

# CONVECTION OVEN WITH ELECTRONIC CONTROLS

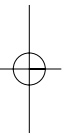

**Instructions for use**

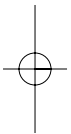
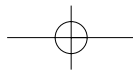

# CONTENTS

CHAP. 1	GENERAL	
1.1	Control panel	3
1.2	Description and accessories provided	4
1.3	Important safeguards	5
1.4	Summary of operation	6
1.5	Correct wire shelf position	7
1.6	Installation	8
1.7	Important tips and techniques	8
CHAP. 2	USING THE CONTROLS AND SETTING THE MODES	
2.1	Setting the clock	9
2.2	Bake and Fan/Bake modes	10
2.3	Broiling mode	14
2.4	Toasting mode	16
2.5	Defrosting mode	17
2.6	Dehydrating mode	18
CHAP. 3	CLEANING AND MAINTENANCE	
3.1	Care and cleaning	19

# 1 GENERAL

## 1.1 - CONTROL PANEL

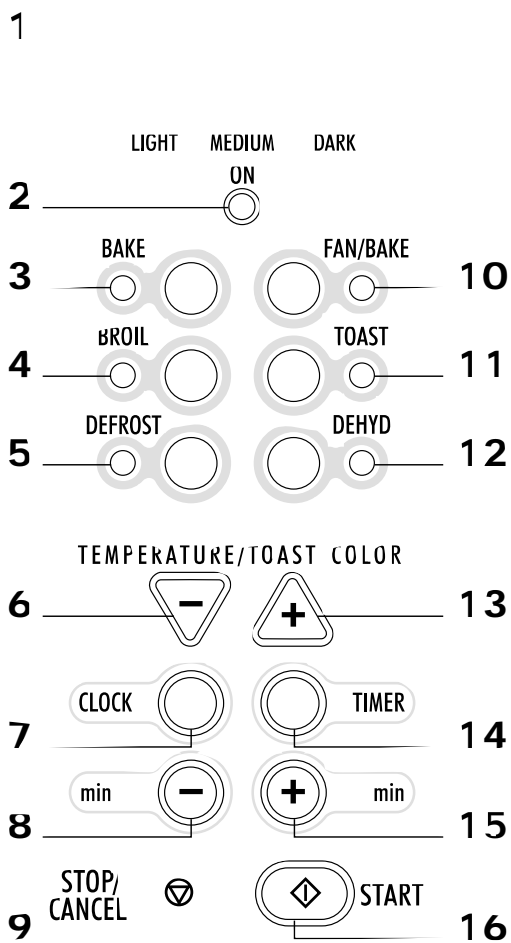

- 1 Display
- 2 ON pilot light
- 3 BAKE button/pilot light
- 4 BROIL button/pilot light
- 5 DEFROST button/pilot light
- 6 TEMPERATURE/TOAST COLOR setting
- 7 CLOCK button
- 8 "min -" button

- 9 STOP/CANCEL button
- 10 FAN/BAKE button/pilot light
- 11 TOAST button/pilot light
- 12 DEHYDRATE button/pilot light
- 13 TEMPERATURE/TOAST COLOR setting
- 14 TIMER button
- 15 "min +" button
- 16 START button

# 1 GENERAL

## 1.2 - DESCRIPTION AND ACCESSORIES PROVIDED

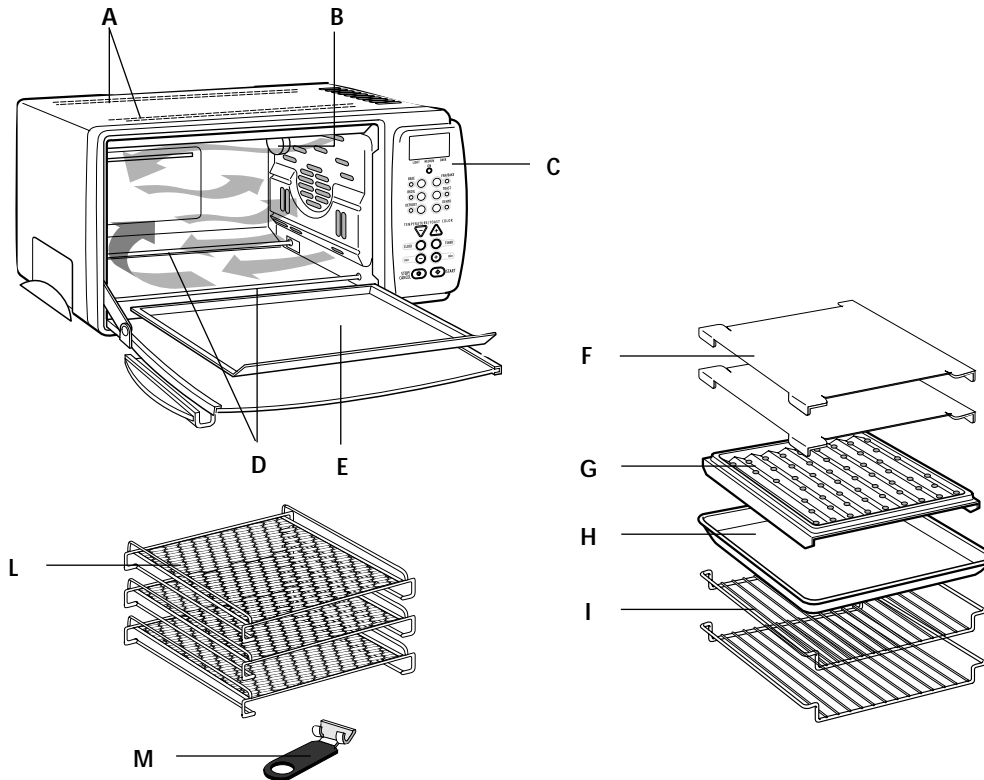

- A Upper heating element
- B Oven light
- C Control panel
- D Lower heating element
- E Crumb tray
- F Cookie Sheet (two provided)
- G Broiling rack
- H Shallow pan
- I Wire shelf (two provided)
- L Dehydrator kit (optional)
- M Handgrip (optional)

# 1 GENERAL

## 1.3 - IMPORTANT SAFEGUARDS

Your product is equipped with a polarized alternating current line plug (a plug having one blade wider than the other).

This plug will fit into the power outlet only one way. This is a safety feature. If you are unable to insert the plug fully into the outlet, try reversing the plug. If the plug should still fail to fit, contact your electrician to replace your obsolete outlet. Do not defeat the safety purpose of the polarized plug.

When using electric appliances basic safety precautions should always be followed, including the following:

- 1) Read all instructions.
- 2) Do not touch hot surfaces. Use handles, dials and hot pads.
- 3) To protect against electrical shock, do not place oven in or under water. See instructions for cleaning.
- 4) Close supervision is necessary when any appliance is used by or near children.
- 5) Unplug from outlet when not in use and before cleaning. Always press the STOP/CANCEL button before unplugging. Allow to cool before putting on or taking off parts and before cleaning the appliance.
- 6) Do not operate any appliance with a damaged cord or plug or after the appliance malfunctions, or has been damaged in any way. Return appliance to the nearest authorized service facility for examination, repair or adjustment.
- 7) The use of accessory attachments not recommended by the appliance manufacturer may cause injuries.
- 8) Do not use outdoors.
- 9) Do not let cord hang over edge of table or counter, or touch hot surfaces.
- 10) Do not place on or near a hot gas or electric burner.
- 11) Extreme caution must be used when moving an appliance containing hot oil or other hot liquids.
- 12) If the plug gets hot, please call a qualified electrician.
- 13) Do not use this appliance for other than intended use.
- 14) Use extreme caution when removing the broiling tray or disposing of hot grease.
- 15) Do not clean oven with metal scouring pads. Pieces can break off the pad and touch electrical parts creating a risk of electric shock.
- 16) To disconnect the appliance, press the STOP/CANCEL button. Then unplug the cord from the wall outlet.
- 17) To assure safe operation, oversized utensils or food must not be inserted into the oven.
- 18) A fire may occur if this appliance is covered or touching flammable material, including curtains, draperies, walls, etc. when in operation.
- 19) Condensation and a grease deposit may form around the door and the air and steam outlet grilles. This is normal.
- 20) CAUTION: Never leave the oven unattended when in use (especially when broiling and toasting).
- 21) Extreme caution should be exercised when using containers other than ovenproof metal, glass or ceramic.
- 22) Do not store any materials other than the manufacturer's recommended accessories in the oven when not in use.
- 23) Do not place any of the following materials in the oven: paper, cardboard, plastic and the like.
- 24) Do not cover crumb tray or any part of the oven with metal foil; this can cause overheating of the oven. Use aluminum foil on or under food only as directed in the appliance instructions.



**THIS PRODUCT IS FOR HOUSEHOLD USE ONLY**

**SAVE THESE INSTRUCTIONS**

# 1

## GENERAL

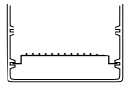
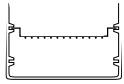
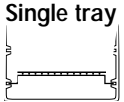
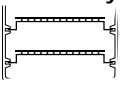
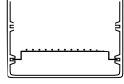
### 1.4 - SUMMARY OF OPERATION

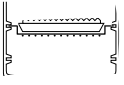
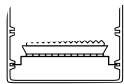
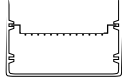
PROGRAM	MODES	TEMPERATURE SETTING/DISPLAY INDICATION	POSITION OF WIRE RACK/ ACCESSORIES	NOTES/TIPS
CONVECTION OVEN COOKING	FAN/BAKE	140° - 450°F	 	Ideal for meat, cakes in general and food which need to be crispy on the surface (as gratined dishes). Roast meats and poultry will cook faster. Use of a meat thermometer will help avoid over-cooking.
		300° - 350°F	Single tray  with cookie sheets	BAKED GOODS: Select one or two wire racks with cookies sheets depending upon the quantity.
CONVECTION OVEN COOKING ON TWO TRAYS SIMULTANEOUSLY	PRESS TWICE FAN/BAKE	2 tr	Double trays  with cookie sheets	Baked foods (cakes, pies, cookies, etc.) may require a lower temperature to prevent over-browning (see page 13)
TRADITIONAL OVEN COOKING	BAKE	140° - 470°F	 	Bake casseroles, pizza fruit desserts, fish, stuffed vegetables, puddings and other moist foods that don't require browning and crisping.
BROILING AND TOP BROWNING	BROIL	brl	 	Always use the broiling rack set in the shallow pan. Place it on the wire shelf in position that puts the food about two inches from the top element, more for thick food such as chicken. Foods such as hamburgers, steaks, kebabs, sausages are to be placed directly on the broiling rack. Use the broil settings to top-brown open-face sandwiches, cheese toppings, hors d'oeuvres.
TOASTING	TOAST	t to t7		Some breads, muffins, etc. will take longer than others. Reset dial if results are too light. Place the bread to be toasted following instructions on page. 16.

# 1 GENERAL

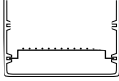
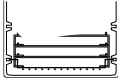
PROGRAM	MODES	TEMPERATURE SETTING/DISPLAY INDICATION	POSITION OF WIRE RACK/ ACCESSORIES	NOTES/TIPS
KEEPING WARM	FAN/BAKE	140°F		Turn to this setting to keep hot food warm. Do not hold food more than an hour or reheat cold food. If not hot enough for serving turn temperature dial up.
DEFROSTING	DEFROST	d Fr		To thaw frozen food in freezer packaging place it on wire shelf or on shallow pan to catch any juices. Do not try to thaw large roasts or allow any food to overthaw (see page. 17).
DEHYDRATING	DEHYD	d Eh		Place prepared food on the dehydrator kit (if provided) without covering shelves with plastic food wrap. The fan and low heat will dry food in 8 to 14 hours. Consult a book on drying foods for treatment of various foods.

## 1.5 - CORRECT WIRE SHELF POSITIONS

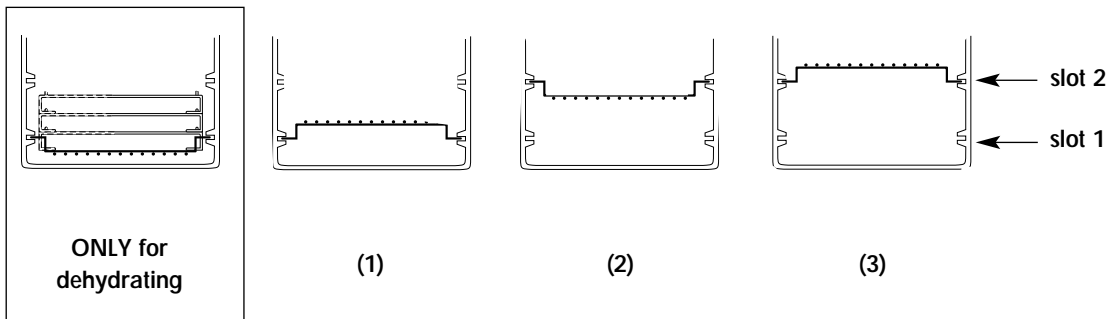

# 1

## GENERAL

### 1.6 - INSTALLATION

- 1) Check that the appliance has not suffered any damage due to transportation.
- 2) Place the appliance on a flat, stable surface out of the reach of children (the glass door becomes very hot while the oven is in operation).
- 3) Before using this appliance, move it two to four inches away from the wall or any object on the counter top. **Remove any object that may have been placed on top of the appliance.** Do not use on surfaces where heat may be a problem.
- 4) Initial start-up operation may result in minimal smell and smoke (about 15 min.). This is normal. It is due to the protective substance on heating elements which protects them from salt effects during shipping from the factory.
- 5) When a function is started, the pilot light B turns on.

### 1.7 - IMPORTANT TIPS AND TECHNIQUES

#### POSITIONING THE WIRE SHELVES:

There are two slots on the sides of the oven. Slide one or both shelves into these positions. The upper shelf can be turned over, allowing three different levels. The recipes will suggest the best arrangement (1 to 3; see page 7) where necessary for best results. The shelf reversed in slot 1 must be used only with the dehydrator kit L (optional).

#### ACCESSORIES AND UTENSILS

The shallow pan H is designed to permit the circulating heat to surround the food (except for the bottom surface) more effectively. Use it as you would any shallow baking or roasting pan. Other utensils you own can be used provided that an inch or so of space remains open to allow circulation of the fan-forced heat. Casserole covers should not be used and glass ovenware should not be placed closer than two inches from the upper heating element.

The cookies sheets F provided **must** also be centered on the shelf.  
When using both sheets on two wire shelves, place wire shelves in position 1 and 3.

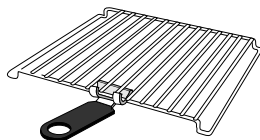

Use handgrip (if fitted) to bring the wire rack out of the oven when it is hot.

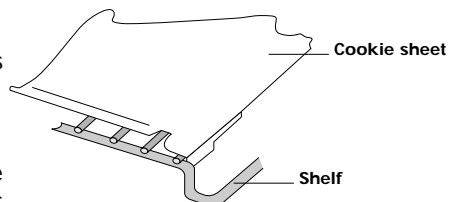

#### PREHEATING THE OVEN

To pre-heat the oven, press the required function (BAKE, FAN/BAKE, BROIL) and set the desired temperature (only for BAKE and FAN/BAKE). After having pressed START, if no duration has been set, the display will show the countdown starting from the default duration of 1:00 (one hour). On reaching the set temperature, the control will emit 3 times 3 beeps. The ON light (2) will stay on.

#### USE ALUMINUM FOIL

Do NOT allow foil to touch sides of the oven or the heating elements. Foil can be used to cover foods or the shallow pan (for easier clean-up) provided foil is tucked in securely around the food or the edges of the pan or dish. DO NOT cover the broiling rack as this can cause accumulated grease to catch fire. DO NOT cover the crumb tray (E).

Unlike an ordinary toaster-oven, the DE'LONGHI features 8 functions: convection and traditional baking and roasting, toasting, broiling, keeping food warm, defrosting frozen foods and even dehydrating sliced fruits for nutritious snacks.



## USING THE CONTROL AND SETTING THE MODES

# 2

### 2.1 - SETTING THE CLOCK

- When the appliance is connected to the domestic power supply for the first time, or after a power out, four dashes will appear on the display (--:--).  
In order to set the time of day, proceed as described below:

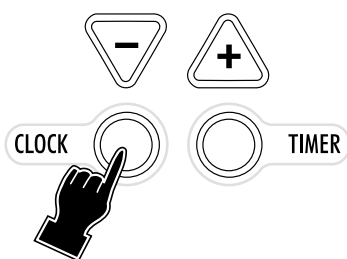

- 1 Press the CLOCK button (7).  
(the hours and the minutes flash on display)

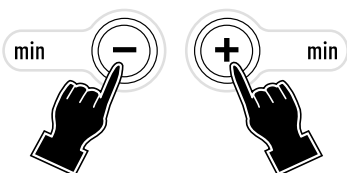

- 2 Set the desired time by pushing the "min +" or "min -" buttons (8-15). The times set will begin blinking on the display.

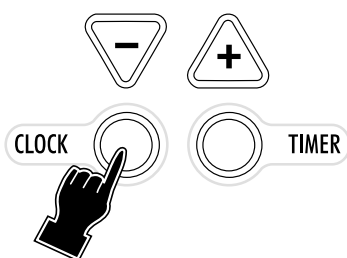
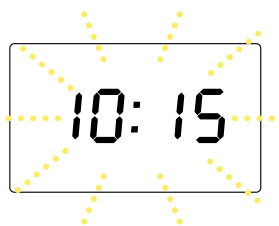

- 1 Press the CLOCK button (7) at any time during cooking to display the current time.  
(the display shows the time set)

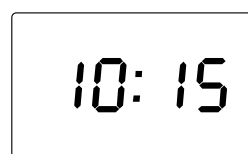



- If you wish to change the hour on the dial once it has been set, press the CLOCK button (7) before proceeding to set the new time as described above.
- It is possible to display the current time even after starting a function, by pressing the clock button (7) (the time is displayed for 2 seconds).

## USING THE CONTROL AND SETTING THE MODES

# 2

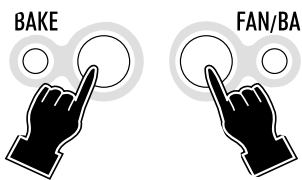
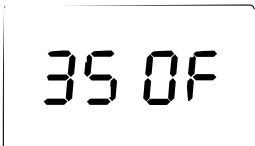
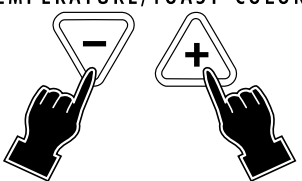
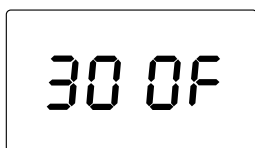
### 2.2 - BAKE AND FAN/BAKE MODES

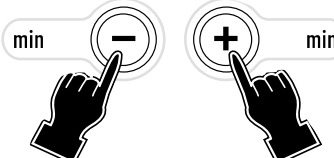
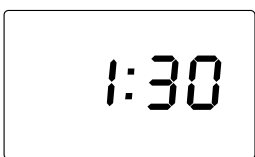
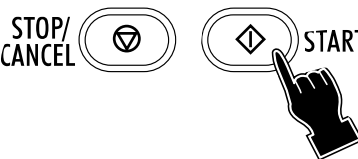
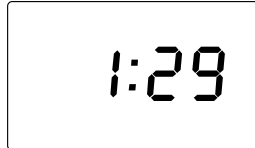
- |  |   |   |
|--|---|---|
|                                 | <p>1 Press the button associated with the required function: BAKE (3) or FAN/BAKE (10). The display will show the default temperature (350°F)</p>   |    |
| <p>TEMPERATURE/TOAST COLOR</p>  | <p>2 If necessary, the desired temperature can be modified by pressing the temperature -/+ buttons (6) or (13). The available temperatures are: 140 - 250 - 275 - 300 - 325 - 350 - 375 - 400 - 425 - 450° F (with BAKE mode up to 470° F). The display will show the chosen temperature.</p> |    |
|                                | <p>3 Then press the TIMER button (14). The display will show 0:00.</p>  |   |
|                               | <p>4 Set the time (max 2 hours) by pressing the "min-" (8) and "min +" (15) buttons. Keep the button pressed for more than 2 seconds to quickly scroll the time up or down. For each press of the button the time will increase or decrease by one 1 minute.</p>                              |  |
|                               | <p>5 Press the START button (16). The oven will start the countdown. At the end of the set time the control will emit 4 beeps and the display will return to stand-by (showing the time of the day, if previously set).</p>   |  |

#### Notes:

- If the cooking time is not set (skipping points 3 and 4), the display will show the countdown starting from the default duration of 1:00 (1 hour).
- The oven should always be preheated. Wait for the available signal (3 times 3 short beeps) before placing the tray (5) with food in the oven.
- The set time can be modified during cooking by simply repeating points 3 and 4. The countdown will automatically restart 3 seconds after the last setting.
- To display the current temperature (during cooking), simply press either one of temperature -/+ : (6) or (13) buttons. To modify the set temperature, press again, within 3 seconds, one of the two buttons until the new desired setting will be displayed.
- If the START button is not pressed within 3 minutes from the previous setting, the control will return to stand-by.

## 2 USING THE CONTROL AND SETTING THE MODES

### GENERAL GUIDELINES

With **FAN/BAKE mode**, a fan gently circulates the heated air within the oven, providing a more even temperature around the food. This system, used in many large commercial ovens for years, produces more even browning and cooking of baked foods, meats and poultry. The forced air also displaces the layer of cold air surrounding the food, allowing faster cooking in many cases or a lowering of temperature. In general, meats and poultry can be cooked in less time (a meat thermometer will help to prevent overcooking). Cakes, pies, cookies, etc. can be baked at a lower temperature (see charts and recipes).

**BAKE mode** is used when browning and crisping are less important or undesirable. Use it, following conventional recipes, for casseroles, stuffed vegetables, fish, lasagna, fruit tarts, cheesecakes and other moist mixtures.

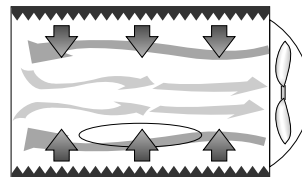

#### IMPORTANT

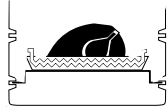

We recommend cooking chicken, roasts and small fowl directly on the broiling rack resting on the dripping-pan (see fig. on the left) to avoid fat spattering onto the sides of the oven and dripping onto the bottom. See the following sections for further details.

### CONVECTION BAKING OF CONVENIENCE FOODS

Many convenience foods can be successfully baked or heated by convection on the FAN/BAKE mode. In general, follow the package directions for temperature and time. **However, lower the temperature by 25°F.** for more even cooking of larger items, frozen foods (except waffles and pancakes) and packaged casserole mixtures. There is such a wide choice of convenience foods on the market and variations in packaging, quantities and initial temperatures (frozen, refrigerated and shelf temperature) that it's best to follow the package instructions. Check the food 5 to 10 minutes before the time is up; you may need to adjust the time and/or temperature for best results.

#### Here are some tips for different types of convenience foods:

- If directions call for placing the food container on a metal pan or cookie sheet to avoid spills or to aid even cooking, use the shallow pan provided. Use it or the cookie sheets provided for foods, such as rolls, cookies, turnovers or frozen French fries, breaded fish or chicken pieces, that are placed directly on a pan or cookie sheet.
- Some frozen foods come in "oven-proof" plastic or paper containers which can be cooked in a microwave oven and, within limits, a conventional oven. Be sure to follow directions for maximum baking temperature. The container can melt or scorch if too high a temperature is used. To be on the safe side, set the oven 25°F. lower than the recommended temperature.
- When baking packaged mixtures (such as scalloped potatoes, macaroni and cheese, brownies, corn bread, coffeecake and cake mixes) check the package directions for recommended sizes of pan, casserole or dish and the proper baking times for each. A 9-inch round or an 11/7 - by 11/2 inch rectangular pan will fit in the oven with room on all sides for air circulation.  
Layer cake mixes can be baked one layer at a time in a 8- or 9-inch round pan or all of the batter in a 3-inch deep 9-inch round bundt or spring-form pan.

### CONVECTION OVEN COOKING ON TWO TRAYS SIMULTANEOUSLY

This special function is designed to produce perfect results when using two trays to bake delicate food items such as cookies, brownies, cakes, pies etc. (see additional notes on page 13). The function is accessible by pressing the FAN/BAKE button twice until you see **2 tr** displayed. Please note, this function is programmed to control temperature, so only the baking time can be adjusted. This function is programmed to control temperature, so only baking time can be adjusted. Follow the full set of instructions as outlined below. The oven should always be pre-heated. Wait for the audible signal (3 times 3 short beeps) before placing the trays with food in the oven.

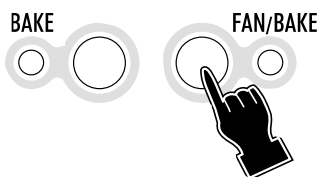

- 1 Press the FAN/BAKE button (10) twice. The display will show the message **2 tr**.

**2 tr**

## USING THE CONTROL AND SETTING THE MODES

# 2

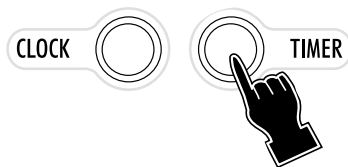

- 3 Then press the TIMER button (14). The display will show 0:00.

0:00

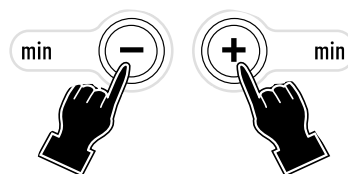

- 4 Set the time (max 2 hours) by pressing the "min-" (8) and "min +" (15) buttons. Keep the button pressed for more than 2 seconds to quickly scroll the time up or down. For each press of the button the time will increase or decrease by one 1 minute.

0:30

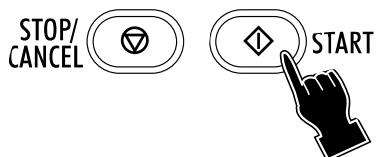

- 5 Press the START button (16). The oven will start the count-down. At the end of the set time the control will emit 4 beeps and the display will return to stand-by (showing the time of the day, if previously set).

0:29

**Note:** At 3/4 cooking time swap the positions of the "cookie sheets" (F) See figure on the right.

For example, if you will bake cookies for 20 minutes, switch positions of cookie sheets (from top to bottom position and vice versa) after 15 minutes for best results.

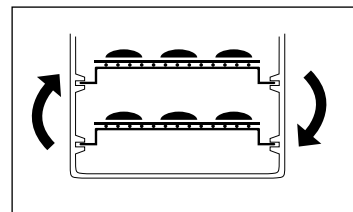

## 2 USING THE CONTROL AND SETTING THE MODES

### TEMPERATURE AND TIME FOR TYPICAL FOODS (convection baking and roasting)

The suggested temperature and times will vary depending on the temperature of the food placed in the oven, the quantity and personal preference. Times given for meat and poultry are for refrigerator temperature. Add five minutes for preheating the oven.

FOOD	MODES	TEMPERATURE SETTING/DISPLAY INDICATOR	APPROX. TIME	NOTES AND TIPS
Whole chicken 3-3.5 lbs. Unstuffed.	FAN/BAKE	350°F	75 min. or until internal temperature of 175°F in thigh and breast	Roast in shallow pan with broiling rack inverted, with shelf in position 1 (see pag. 7)
Pork Loin or Rib Roast, 2 - 4 lbs.	FAN/BAKE	325°F	90 min. or until internal temperature of 170°F is reached.	Roast as for whole chicken. Broiling rack may be in its higher position if oven space allows.
Pork Baby Back Ribs 1.75 - 2 lbs. in 6 - to 10 - inch strips.	FAN/BAKE	300°F for 20 min. then BROIL for 30 min.	Total time 50 min. or until brown and very tender.	Use pan without rack, lined with foil, on shelf position 1. See recipe to follow for full directions.
Beef Sirloin or Rib Roast 3 - 5 lbs., boned.	FAN/BAKE	350°F	20 min./lb. for rare 25 min./lb for medium 30 min./lb. well	Have roast tied for even cooking. Use broiling rack in low or high position as oven space allows.
Cornish Hens 1.5 lbs. each, two split into four halves.	FAN/BAKE	350°F	45 - 50 min. or until tender and juice is clear when pierced with fork.	Roast on pan with broiling rack in high position, skin side up. Brush with orange marmalade or honey. Turn and brush several times until done.
Baking Potatoes 1 to 4 large	BAKE	450°F	45 - 50 min. or until fork-tender.	Wash and pierce raw potatoes with fork. Rub skins with salad oil if desired. Bake on wire shelf in position 1 or 2.
Pizza, homemade.	BAKE	450°F to 470°F	20 - 25 min. depending on size and topping. Bake until bubbling hot and crust crisp.	Place pizza pan or stone on wire shelf in position 1.
Cakes: Layer, Sheet cake or Loaf cake. Pies: Fruit, 9- inch double crust.	FAN/BAKE one tray	300°F to 350°F	Cake: Follow traditional recipe timing but lower temperature by 25 to 50°F.	Cake: Place wire shelf in position 1. Check for doneness 5 - 10 min. before time is up. Cut while still warm. Let cool 5 - 10 min. to firm up before removing from pan or dish.
	Press twice FAN/BAKE two trays	2 tr	Cookie: After the preheating signal. 20-30 minutes, depending on the type of biscuit	
Brownies, Bar, Cookies	FAN/BAKE one tray	300 to 325°F	Cake: Follow traditional recipe timing but lower temperature by 25 to 50°F. Use 7x11 inch or 8- or 9 inch square pan or oven-glass dish.	Cookie: Place 1 inch apart on 1 or 2 cookie sheets. For 1 sheet place wire rack in position 1. For 2 place racks in 1 and 3 positions. Grease sheets if the recipe directs. Remove promptly to cooling rack.
	Press twice FAN/BAKE two trays	2 tr	Cookie: After the preheating signal. 20-30 minutes, depending on the type of biscuit	





### KEEP FOOD

This function will allow the freshly-cooked food to be kept warm without drying out (we also suggest the food be covered with foil). Set the FAN/BAKE function to 140°F for the desired time.

## USING THE CONTROL AND SETTING THE MODES

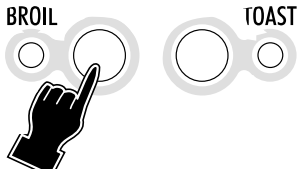
# 2

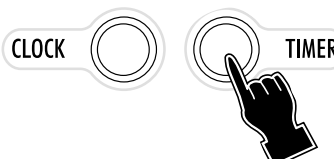
### 2.3 - BROILING MODE

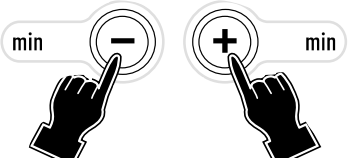
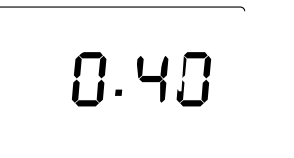
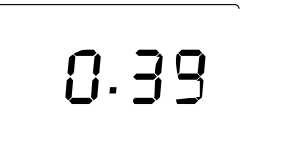
	<p>1 Press the BROIL button (4). The display will show the message <i>b r l</i>.</p>	
	<p>2 Press the TIMER button (14). The display will show <i>0:00</i>.</p>	
	<p>3 Set the time (max 2 hours) by pressing the "min-" (8) and "min+" (15) buttons.</p>	
<p>4 Press the START button (16). The oven will start the count- down. At the end of the set time the control will emit 4 beeps and the display will return to stand-by (showing the time of the day, if previ- ously set).</p>		

#### Notes:

- If the cooking time is not set, the display will show the countdown starting from the default duration of *1:00* (1 hour).
- If the START button is not pressed within 3 minutes from the previous setting, the control will return to stand-by.
- **Always leave the door open to the stop position** (as shown in the figure 1).
- Preheat 5 to 10 minutes on BROIL.
- Trim excess fat from meat. Dry meat, fish and poultry surfaces with paper towel.
- Place the food on the broiling rack set in the shallow pan as shown in the figure 2). Position wire shelf so that food will be about 2 inches from top heating element. Thick foods such as chicken pieces should be 3 - 4 inches from the element.
- The broiling rack can be inverted if necessary, but do not attempt to broil without the rack as fat drippings can smoke or flame.
- For easier clean-up, the shallow pan can be lined with foil. Be sure not to cover the broiling rack or let foil extend beyond the edges of the pan.
- Be careful when turning food or removing the pan. Use hot pads and avoid spilling drippings.
- **Never cover heating elements with foil.**
- To top-brown casseroles with crumb or cheese toppings, place the dish directly on the

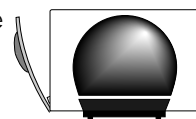

fig. 1

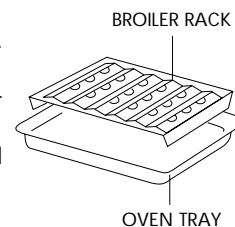

fig. 2

## USING THE CONTROL AND SETTING THE MODES

wire shelf 2 - 3 inches from the top element. Leave the door open to the stop position and watch carefully to avoid burning the toppings. NOTE: Oven-glass dishes should not be exposed to direct broiler heat.

When the function and the temperature controls are set to BROIL only the top element heats at full power. Be sure to leave door open to stop position only, as shown in the figure 1 on page 14. Set the broiling rack in the drip pan on the wire shelf in position 2 or 3 (see pag. 7) so that the food is few inches from the top element. For thick foods such as chicken parts place the shelf in position 1. If necessary, the broiling rack can be inverted in the pan. The broiling rack shields the fat drippings from direct heat, reducing spattering, smoking and possible flaming. Always use the shallow pan when broiling any fatty foods.

### SUGGESTED BROILING TIMES

FOOD	WEIGHT OR THICKNESS	APPROX. TIME (Turn at half time)
Beef Sirloin, Porterhouse Steak	1- 1 1/2 in.	Rare 12 - 15 min. Medium 16 - 18 min.
Beef Flank Steak, Filet	3/4 - 1 in.	Rare 10 - 12 min. Medium 13 - 16 min.
Hamburger	1 in.	Medium-well 15 - 18 min.
Pork Chop	3/4 - in.	Well 18 - 22 min.
Fish Fillets, Steak (See note)	1/2 - 1 in.	10 - 16 min.
Chicken Piece, Broiler-fryer	3 - 4 lb.	40 - 50 min. until juices run clear when fork-tested and no pink when cut.
Bacon, Sausage, Links or Patties	Up to capacity of broil-rack.	10 - 15 min. for crisp bacon, well-done sausage.

Since fish is non-fatty it can be broiled directly on shallow pan. Broil until it flakes easily with a fork. Thin fillets need not to be turned.

## USING THE CONTROL AND SETTING THE MODES

# 2

### 2.4 - TOASTING MODE

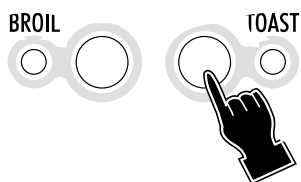

1 Press the TOAST button (11).  
The display will flash **t 4**.

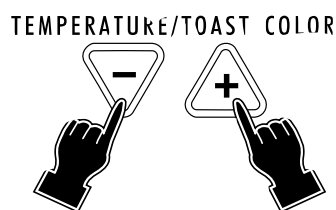
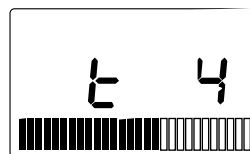

2 Press TEMPERATURE/TOAST COLOR -/+ adjust buttons (6) and (13) to modify the desired level of toasting.

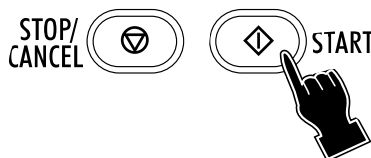
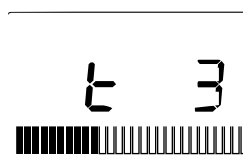

3 Press the START button. The display will show the toasting time. At the end of the set time the control will emit 4 beeps and the display will return to stand-by (showing the time of the day, if previously set).

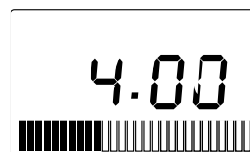

**Note:**

- You have seven browning selection shades to choose from (indicated on the display with "t t2 t3 t4 t5 t6 7")
- When toasting, the toasting time will count down on the clock display. The timing will be different for each custom setting you choose. Keep in mind that the timing is adjusted by the oven thermostat. So if your oven is already warm, the toasting time will be less than if you start with a cold oven.
- Should it be necessary for any reason to suspend the cooking, you only need press the STOP/CANCEL (9). The display will go back to showing the clock.
- If the START button is not pressed within 3 minutes from the previous setting, the control will return to stand-by.
- Correct position of the slices according to number.

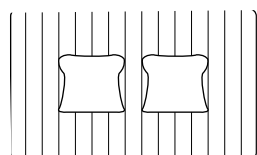

2 slices

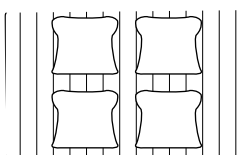

4 slices

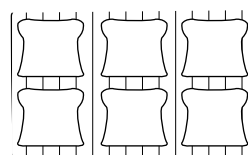

6 slices

Naturally, to toast a smaller number of slices, choose a lower toasting level.  
example:



2 slices	light	set t2
6 slices	light	set t4



## USING THE CONTROL AND SETTING THE MODES

# 2

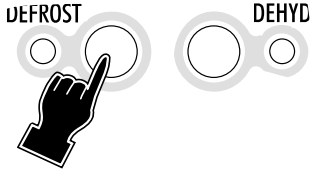
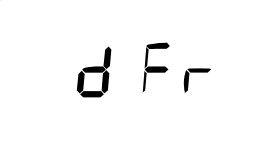
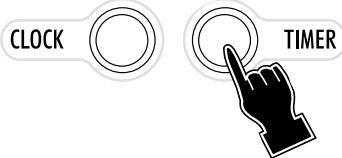
### 2.5 - DEFROSTING MODE

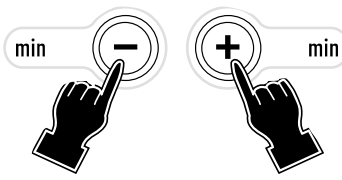
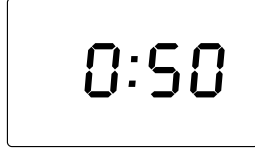
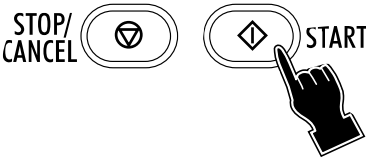
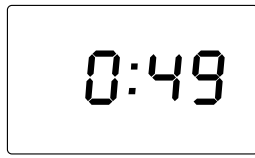
	<p>1 Press the DEFROST button (5). The display will flash <i>d Fr</i></p>	
	<p>2 Then press the TIMER button (14). The display will show <i>0:00</i>.</p>	
	<p>3 Set the time (max 2 hours) by pressing the "min-" (8) and "min +" (15) buttons. Keep the button pressed for more than 2 seconds to quickly scroll the time up or down. For each press of the button the time will increase or decrease by one 1 minute.</p>	
	<p>4 Press the START button (16). The oven will start the count-down. At the end of the set time the control will emit 4 beeps and the display will return to stand-by (showing the time of the day, if previously set).</p>	

#### Notes:

- If the defrosting time is not set (skipping points 2 and 3), the display will show the countdown starting from the default duration of *1:00* (1 hour).
- If the START button is not pressed within 3 minutes from the previous setting, the control will return to stand-by.

Portions and pieces of raw meat, poultry and fish, frozen soups, pastry, fruit or leftovers will thaw more quickly on this setting than on a counter or in the refrigerator.

Thaw only pieces or portions small enough to thaw in an hour or less and do not let food come to room temperature.

Thawed food held too long or at a warm temperature can cause serious illness.

Large amounts of food should be defrosted in a refrigerator.

## USING THE CONTROL AND SETTING THE MODES

# 2

### 2.6 - DEHYDRATING MODE

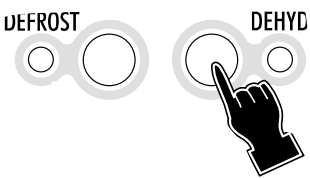
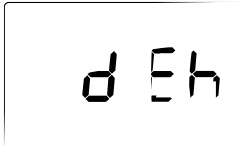
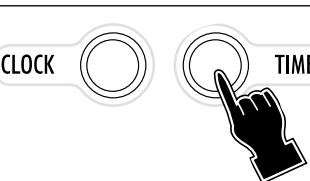
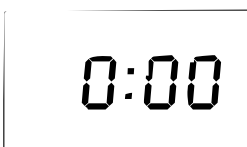
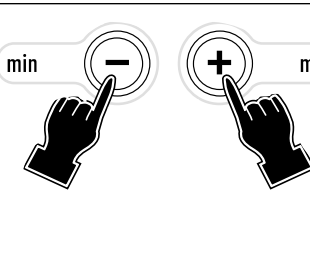
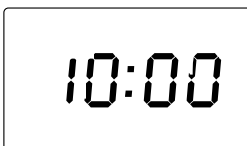
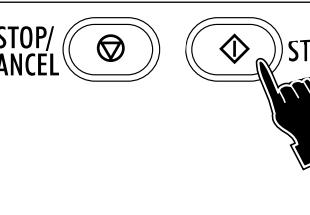
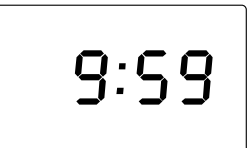
	<p>1 Press the DEHYD button (12). The display will flash <i>d Eh</i>.</p>	
	<p>2 Press the TIMER button (14). The display will flash <i>0:00</i>.</p>	
	<p>3 Set the time (max 14 hours) by pressing the "min-" (8) and "min +" (15) buttons. Keep the button pressed for more than 2 seconds to quickly scroll the time up or down. For each press of the button the time will increase or decrease by one 1 minute.</p>	
	<p>4 Press the START button (16). The oven will start the count-down. At the end of the set time the control will emit 4 beeps and the display will return to stand-by (showing the time of the day, if previously set).</p>	

Slices of apples, pineapple, pears, peaches or bananas, placed directly on the dehydrator kit (if supplied), will dry in 8 to 14 hours in the gently circulating warm air. Time will depend on the moisture in the fruit. Herbs can also be dried. However, the limited quantity of vegetables that can be dried at one time may not be worth your time and attention. Consult a book on dehydrating food for specific directions as to times, temperature, pretreatment and storage of dried foods.

#### FOR DEHYDRATING:

- Always leave the door open to the stop position (as shown in figure).
- Prepare food and use the dehydrating kit DE'LONGHI as follows:
  - insert wire shelf, inverted in the slot 1;
  - put the dehydrator kit on the wire shelf (see figure).

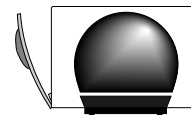

Dehydrating kit



Slot 1 →

← wire shelf reversed

## CLEANING AND MAINTENANCE

### 3.1 - CARE AND CLEANING

---

**Always unplug the toaster-oven-broiler and allow it to cool before cleaning.** This unit has been designed and engineered with your safety in mind. To assure maximum safe operation, keep unit clean free of grease and build up of food particles.

1. Remove the wire oven rack.
2. To clean the inside walls, use a damp cloth and a mild liquid soap solution. Never use harsh abrasives, corrosive products or spray detergents.

**Note:**

Do not clean interior with metal scouring pads. Pieces can break off and touch electrical parts, creating risk of electrical shock.

3. To clean the glass door, use a glass cleaner or a damp cloth. Wipe dry with a clean cloth.
4. To clean the exterior finish, use a damp, sudsy cloth. For stubborn stains, a non-abrasive liquid cleaner or spray glass cleaner may be used. Do not use metal scouring pads, as they might mar the finish. Always remove cleaning agents by polishing with a dry cloth.
5. The wire rack, the oven pan and the broiling rack may be washed as other kitchenware.

#### OTHER SERVICING

Any servicing requiring disassembly should be performed by an authorized service representative. If the display shows *ER* (error), it means that the oven is damaged.

#### INTERIOR LIGHT

It remains on during all cooking operations. To replace a burned out bulb unscrew the protective glass cover. Remove the bulb and replace it with the same type, a high-temperature appliance bulb.

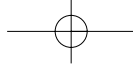

## Limited Warranty

**What Does This Warranty Cover?** We warrant each appliance to be free from defects in material and workmanship. Our obligation under this warranty is limited to replacement or repair, free of charge at our factory or authorized service centers, of any defective part or parts there of other than parts damaged in transit, which shall be returned to us, transportation prepaid. This warranty shall apply only if the appliance is used in accordance with the factory directions which accompany it, and on an Alternating Current (AC) circuit.

**How Long Does The Coverage Last?** This warranty runs for one year from the date of delivery and applies only to the original purchaser for use.

**What Does This Warranty Not Cover?** This warranty does not cover defects or damage of the appliance which result from repairs or alterations to the machine outside our factory or authorized service centers, nor shall it apply to any appliance which has been subject to abuse, misuse, negligence or accidents. Also, consequential and incidental damages resulting from the use of this product or arising out of any breach of contract or breach of this warranty are not recoverable under this warranty. Some states do not allow the exclusion or limitation of incidental or consequential damages, so the above limitation may not apply to you.

**How Do You Get Service?** If repairs become necessary or spare parts are needed, please write to:

De'Longhi America Inc.  
Park 80 West Plaza One 4th floor  
Saddle Brook, NJ 07663  
or call Service Tel. No. 1-800-322-3848

The above warranty is in lieu of all other express warranties and representations; All implied warranties are limited to the applicable warranty period set forth above. This limitation does apply if you enter into an extended warranty with De'Longhi. Some states do not allow limitations on how long an implied warranty lasts, so the above exclusions may not apply to you. De' Longhi does not authorize any other person or company to assume for it any liability in connection with the sale or use of its appliance.

**How Does State Law Apply?** This warranty gives you specific legal rights, and you may also have other rights which vary from state to state.

