

---

**OWNER'S INSTRUCTIONS  
MODE D'EMPLOI**

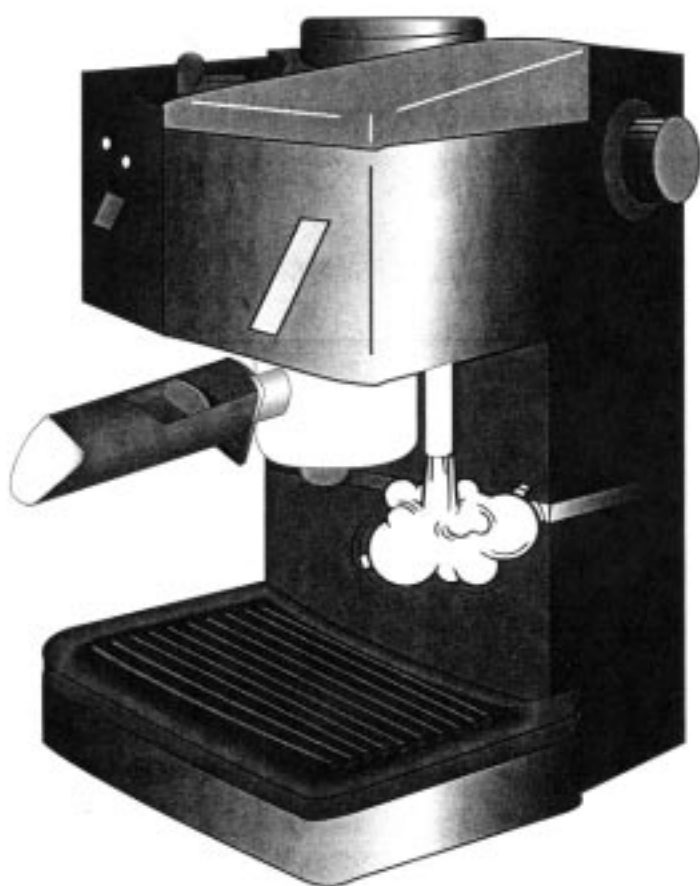

**Coffee/cappuccino maker  
Machine à café express/cappuccino**



**READ AND SAVE THESE INSTRUCTIONS  
LISEZ ET GARDEZ CES INSTRUCTIONS**

---

**BAR9**

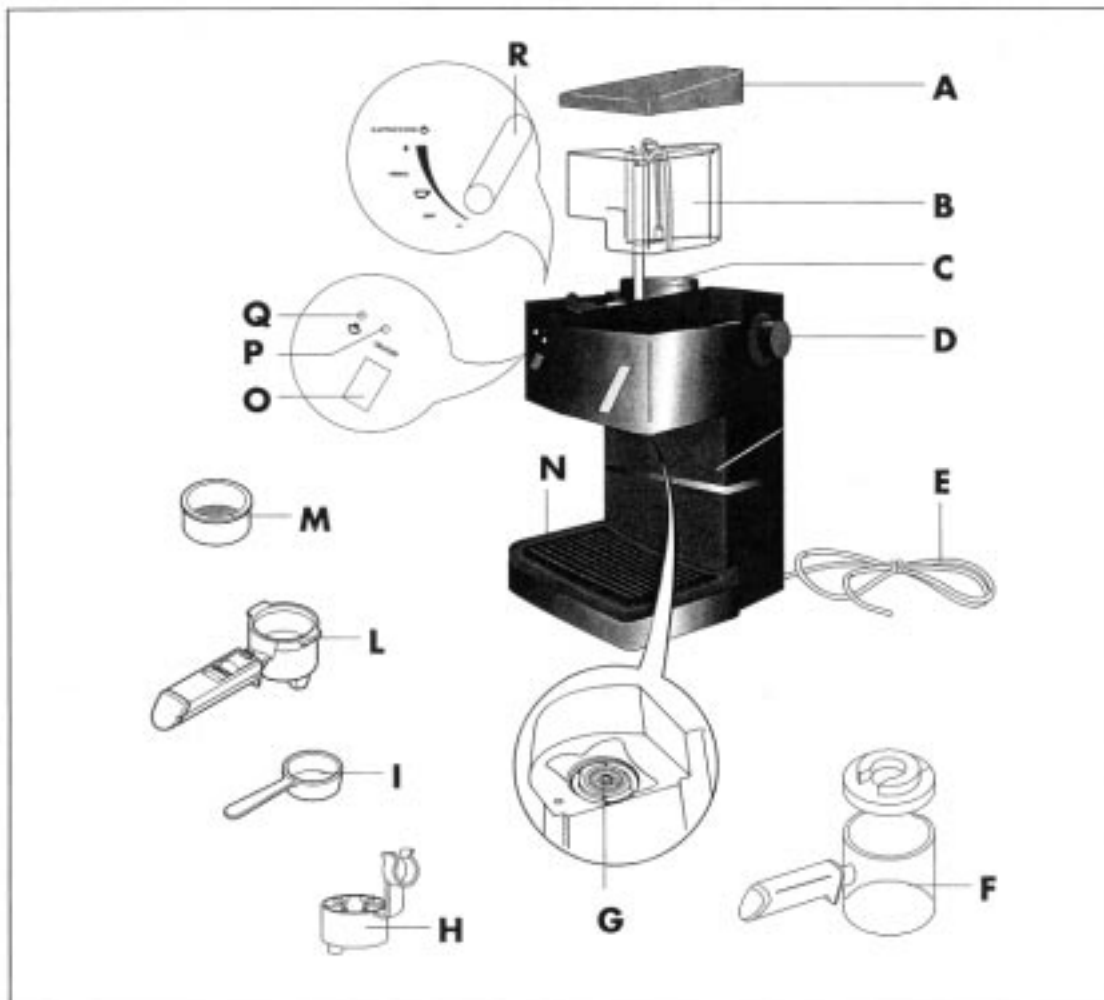

### Description of the appliance

- A** Removable milk reservoir cap
- B** Milk reservoir with instant froth dispenser
- C** Removable cap with safety valve
- D** Steam knob
- E** Power cable
- F** Carafe with lid
- G** Boiler outlet
- H** Adaptor for cups (if supplied)
- I** Measuring spoon
- L** Filter-holder
- M** Filter
- N** Removable drip tray
- O** ON/OFF switch
- P** ON/OFF pilot lamp
- Q** "OK" pilot lamp
- R** Flow regulator with selection for LIGHT or STRONG coffee

### Description de l'appareil

- A** Couvercle amovible du réservoir de lait
- B** Réservoir de lait avec distributeur de mousse
- C** Bouchon amovible avec vanne de sécurité
- D** Bouton ouverture vapeur
- E** Cordon électrique
- F** Verseuse avec couvercle
- G** Sortie de la chaudière
- H** Adaptateur (si prévu)
- I** Cuillère de dosage
- L** Porte-filtre
- M** Filtre
- N** Egouttoir amovible
- O** Interrupteur ON/OFF (marche /arrêt)
- P** Voyant ON/OFF (marche/arrêt)
- Q** Voyant OK
- R** Régulateur de flux avec sélection pour café LIGHT (allongé) ou STRONG (corsé)

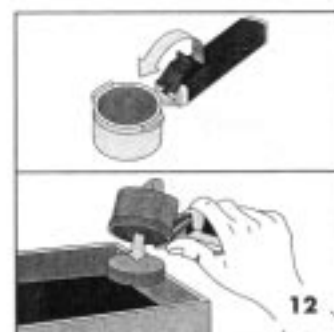
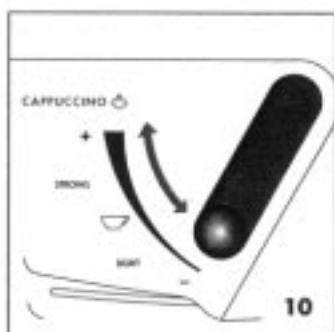
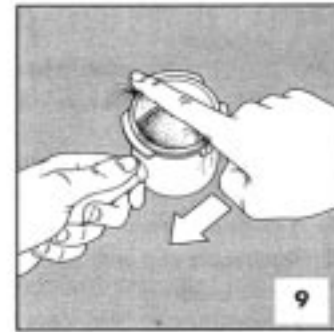
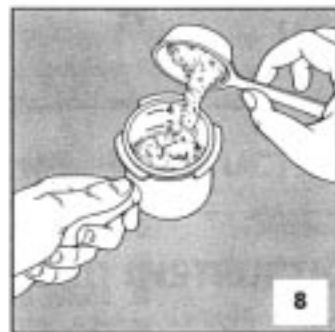
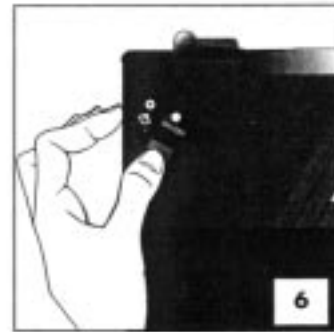
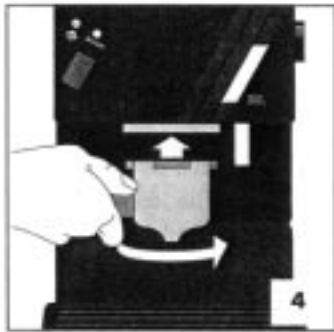
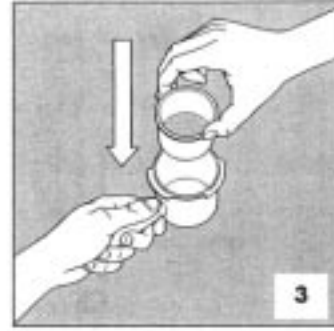
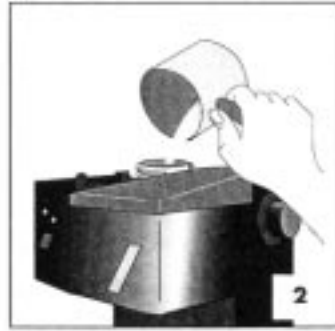

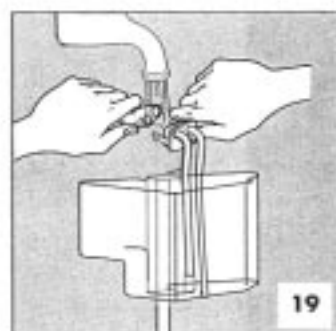
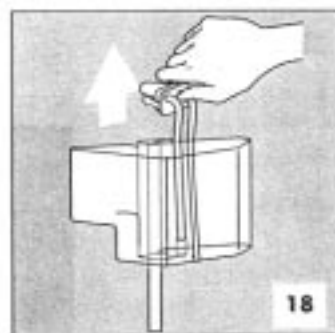
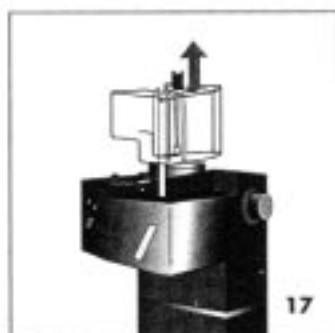
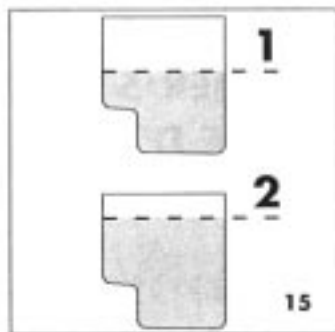

## IMPORTANT SAFEGUARDS

When using electrical appliances, basic safety precautions should always be followed, including the following:

- Read all instructions.
- Do not touch hot surfaces. Use handles and knobs.
- To protect against fire, electrical shock and personal injury, do not immerse cord, plug or appliance in water or other liquid.
- Close supervision is necessary when any appliance is used by or near children.
- Unplug from the outlet when not in use and before cleaning. Allow to cool before fitting or taking off parts, and before cleaning the appliance.
- Do not operate with a damaged cord or plug, or after the appliance malfunctions, or has been damaged in any manner. Return the appliance to the nearest authorized service facility for examination, repair or adjustment.
- The use of accessory attachments or spare parts not recommended by the appliance manufacturer may result in fire, electrical shock or personal injury.
- Do not use outdoors.
- Do not let the cord hang over the edge of the table or counter, or touch hot surfaces.
- Do not place on or near a hot gas or electrical burner, or in a heated oven.
- Always attach plug to appliance first, then plug cord into the wall outlet. To disconnect, turn any control to "off", then remove plug from wall outlet.
- Do not use the appliance for other than the intended use.
- DO NOT unscrew or remove boiler cap while the machine is in operation. Wait until brewing cycle is completed and all water and steam has been used up.
- Appliances with Glass Containers:
  - A. The container is designed for use with this appliance. It must never be used on a range top.
  - B. Do not set a hot container on a wet or cold surface.
  - C. Do not use a cracked container or a container having a loose or weakened handle.
  - D. Do not clean container with cleansers, steel wool pads, or other abrasive material.

## SAVE THESE INSTRUCTIONS

## SHORT CORD INSTRUCTIONS

- A short power cord is provided to reduce risks resulting from becoming entangled in or tripping over a longer cord.
- Longer, detachable power supply cords or extension cords are available and may be used if care is exercised in their use.
- If an extension cord is used, the marked electrical rating should be at least as great as the electrical rating of the appliance. If the appliance is provided with 3-wire, grounding type cord, the extension should be a GROUNDING TYPE 3 - WIRE CORD. The longer cord should be arranged so that it will not drape over the counter-top or table top where it can be pulled on by children or tripped over.
- Your product is equipped with a polarized alternating current line plug (a plug having one blade wider than the other). This plug will fit into the power outlet only one way. This is a safety feature. If you are unable to insert the plug fully into the outlet, try reversing the plug. If the plug should still fail to fit, contact your electrician to replace your obsolete outlet. Do not defeat the safety purpose of the polarized plug.

## INTRODUCTION

Dear customer,

You are now the proud owner of a fine De'Longhi Coffee Maker, you can enjoy the taste of delicious espresso or cappuccino at the end of a perfect meal with family or friends.

The enclosed material has been carefully prepared, to familiarize you completely with the operation of this machine.

Please read all instructions fully before attempting to operate this appliance.

## BECOME FAMILIAR

Before using your De'Longhi coffee maker for the first time, it is important that you become familiar with all of its parts. Do this by means of a practice run. **DO NOT PLUG IN.**

Unscrew the reservoir cap of the espresso/ cappuccino maker turn the steam knob back and forth a few times, place the filter in the filter holder, and position it in the boiler outlet.

## USE OF THE MACHINE

THIS MACHINE IS FOR HOUSEHOLD USE ONLY

### Before use

Before using the machine for the first time, wash all accessories (filter-holder, measuring spoon, filter, carafe, adaptor, if supplied, milk tank) with detergent and warm water, then rinse thoroughly. The internal circuit should then be washed as follows:

### Filling the water tank

- Unscrew the water tank cap by turning counter-clockwise; lift the cap upwards and turn counter-clockwise to remove.
- Use the glass carafe (fig. 1) to fill the water tank (fig. 2). Always switch the machine off and remove the plug from the socket before filling the water tank.

**Do not overfill the water tank. The carafe is marked with the water levels for 2 cups (minimum) and 4 cups (maximum) (see table, page 10).**

**Important: When making cappuccino, add extra water to the steam level shown on the carafe for two cups and to the bottom of the metal band for four cups.**

**Care should be taken to ensure that the correct quantity of water is placed in the tank, as the machine always uses all the water.**

- Close the water tank cap securely by turning clockwise.

### Pre-wash

- Plug the appliance into the wall socket (remember the safety instructions).
- Fit the filter to the filter-holder (fig. 3).
- To fit the filter-holder to the machine, place the filter-holder underneath the boiler nozzle (fig. 4); push the filter-holder upwards and, at the same time, turn it to the right.  
The handle of the filter-holder does not have to be straight when it is attached to the machine. What is important is that it is inserted securely.
- Place the carafe under the filter-holder. Ensure that the spout is aligned with the hole in the carafe lid (fig. 5).
- Turn the flow regulator towards the "LIGHT" position.
- Press the ON/OFF switch. The pilot lamp will light (fig. 6).
- Check that the steam knob is in the closed position.

The water is heated in about 2 minutes, and will then begin to flow from the filter holder nozzle.

When all the water has been delivered, press the ON/OFF switch to turn the machine off.

**Before unscrewing the water tank cap, check that there is no residual pressure in the boiler.** To do this, turn the steam knob slowly so that the residual pressure is allowed to disperse (fig. 7). Do not remove the water tank cap until the steam ceases to escape from the milk tube.

To ensure perfect pre-washing, repeat this procedure several times.  
The machine is now ready for use.

**For best results, we recommend the use of coarse-ground coffee.**

## HOW TO MAKE A PERFECT ESPRESSO COFFEE

Espresso coffee is served in "demitasse" cups (2 - 2<sup>1</sup>/<sub>2</sub> oz.).

- Unscrew the water tank cap by turning it counter-clockwise and pulling it upwards.
- Pour the desired quantity of water into the water tank using the glass carafe. Follow the instructions in the paragraph "Filling the water tank" (see table, page 10).
- Close the tank cap carefully by turning it clockwise.
- Place the desired quantity of coffee in the filter (fig. 8). Spread the coffee evenly and press down lightly with the bottom of the measuring spoon. Special marks on the inside of the filter show the appropriate levels for 2 and 4 cups of coffee.
- Remove any excess coffee from the edge of the filter (fig. 9).
- Position the filter-holder underneath the boiler nozzle. Attach to the machine by pushing it upwards and, at the same time, turning to the right (fig. 4).  
The carafe should be placed under the filter-holder in such a way that the nozzle is aligned with the hole in the lid of the carafe (fig. 5).
- Position the lever according to the type of coffee desired: "LIGHT", or "STRONG" (fig. 10).
- Press the ON/OFF switch. The pilot lamp will light.
- Check that the steam knob is in the "closed" position.  
The coffee will start to flow from the filter holder nozzle after about 2 minutes (fig. 11). Wait until all the water in the water tank is delivered.
- Set the ON/OFF switch to OFF.
- **Before removing the boiler cap or the filter-holder, check that there is no residual pressure in the boiler (see "Pre-wash").**
- To remove the used coffee grounds, turn the filter-holder face-down and knock the grounds out (fig. 12). Alternatively, hold the filter-holder and the filter underneath a running tap for a few moments, then allow to drain.

**Warning: Metal parts may become very hot**

### Installing the cup adaptor (if supplied)

The carafe can be used to brew 2 or 4 cups of coffee.

If you prefer to brew 2 cups only, fit the adaptor to the lower section of the filter-holder (fig. 13) and place the cups directly underneath the nozzles. In this way, the coffee will flow directly into the cups.

## CAPPUCCINO STEP-BY-STEP: HOW TO MAKE A REAL ITALIAN CAPPUCCINO

### Here's what you need

- Ground coffee
- Fresh milk (should be chilled before use)
- A teaspoon - Note: Cappuccino is served in 4 oz. or 5 oz. cups.
- Sugar or sweetener

### STEP-BY-STEP INSTRUCTIONS

- Prepare the machine as described in the paragraph "How to make a perfect espresso coffee".  
**Remember, if you want 2 cappuccinos, fill the carafe up to the "☝" mark. If you want 4 cappuccinos, fill to the bottom of the metal band.**
- Place the cups under the filter-holder.
- Turn the machine ON by pressing the ON/OFF switch.

- When the desired quantity of coffee is obtained, set the flow regulator to . In this way the coffee will stop flowing.
- After a few minutes the "OK" pilot lamp will light to indicate that the machine has reached the correct temperature for using the Instant Froth Dispenser.
- In the meantime, pour the amount of milk necessary for making 1 or 2 cappuccinos into the milk container (fig. 14). For 1 or 2 cappuccinos, fill to the 1 level, for 3 or 4 cappuccinos, fill to the 2 level. (See fig. 15).
- When the OK light has gone on, shift the cups containing the espresso under the Instant Froth Dispenser, and gradually turn the steam knob counterclockwise.  
When you have reached the desired quantity of cappuccino, turn the steam knob clockwise.  
Repeat the same procedure for a second cappuccino then switch the appliance off.  
Your cappuccino is ready. Add sugar to taste and, if you like, sprinkle with a little chocolate powder or cinnamon.
- **After making the cappuccino, the milk container must be carefully cleaned.**

We suggest that you proceed as follows:

- By using the glass carafe pour the amount of water necessary for making 2 coffees, into the water tank.
- Replace the cap.
- Fill the milk container half-way with water.
- Turn the machine ON and set the flow regulator to light.
- When water begins to flow from the boiler nozzle, position the flow regulator lever to  then turn the steam knob counter-clockwise after having placed a receptacle underneath the milk tube (fig. 16).

This procedure will rinse out the milk container as well as all the internal parts.

Once a week, it is best to clean the unit even more thoroughly, as follows:

- Remove the milk container from the machine by pulling it upwards (fig. 17).
- To clean the mixer, pull it upwards (fig. 18). Remove the rubber joint. Wash the joint and the mixer with hot water (fig. 19) or if you prefer wash them in a dishwasher.
- Once they have been cleaned, the parts should be reassembled, taking care not to damage them or fit them incorrectly.

**Before carrying out any cleaning or maintenance operations, check whether there is pressure in the water tank by turning the steam knob slowly counter-clockwise.**

**Never remove the milk container when the steam knob is open; this could cause burns.**

## DESCALING

If you live in a hard-water area, minerals and calcium found in the water will accumulate and affect the operation of the machine.

Approximately **every 1 - 2 months** (depending on the hardness of the water), your DE' LONGHI espresso maker should be cleaned with vinegar as follows:

- Before cleaning your Espresso maker, turn the switch to OFF and remove the plug from the wall socket.
- Fill the carafe with vinegar and pour into the water tank.
- Fit the tank cap and tighten it securely.
- Fit the filter and filter-holder (without any coffee).
- Place the carafe on the drip tray.
- Insert the plug into the wall socket.
- Turn the switch to ON. After a few minutes, the hot vinegar will begin to flow through the filter-holder into the carafe.



- When no more vinegar flows into the carafe, turn the switch to OFF and allow the machine to cool. Remove the filter-holder, the filter and the carafe and rinse with hot water.
- Repeat the last two steps using cold water in order to remove any residual vinegar. Repeat twice.

### **CLEANING AND MAINTENANCE**

- Before carrying out any cleaning or maintenance operations, switch the machine off, remove the plug from the socket and leave the machine to cool.
- Do not use solvents, detergents or abrasive products to clean the machine. A soft damp cloth is sufficient.
- Clean the filter-holder, filter and drip tray regularly. Remember to clean also the milk tank housing.
- Do not wash the machine - remember that it is an electrical appliance.











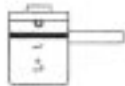
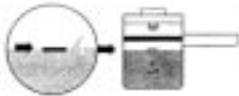

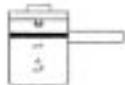

#### **IMPORTANT:**

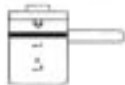
NEVER unscrew the water tank cap or remove the filter-holder when the machine is switched on, as the boiler is under pressure.

In order to check whether there is pressure in the water tank:

- Switch the machine off.
- Remove the plug from the wall socket.
- Turn the steam knob slowly counter-clockwise.
- If steam escapes from the milk tube, then the water tank is still under pressure.
- Place a receptacle under the milk tube.
- Open the steam knob so that the residual steam can escape.
- When all the steam has escaped from the tube, close the steam knob by turning it clockwise.

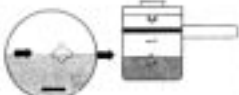
At this point, the water tank cap and the filter-holder can be removed.

IF YOU WANT	USE	WATER	MILK	COFFEE
4 CUPS OF COFFEE				
4 CUPS OF CAPPUCCINO				
2 CUPS OF COFFEE	 or 			
2 CUPS OF CAPPUCCINO	 or 			

Refer to the instructions when making coffee or cappuccino.

### SERVICE AND REPAIR

Do not attempt to repair your DeLonghi appliance. Should the appliance malfunction, contact your nearest authorized service facility, or contact DeLonghi America Inc., Carlstadt, NJ07072. Any attempt to open the housing or to repair the machines, will void the warranty.

## COFFEE RECIPES

### *VIENNESE COFFEE*

Delicious Viennese coffee is easy to make. Prepare strong coffee and cover it with a very thick layer of whipped cream.

### *MOCHA*

Mocha coffee shows how well coffee and chocolate blend together. Mix a cup of coffee with a cup of hot chocolate. Do not let it boil. Sweeten to taste.

### *AMERICAN COFFEE*

For each person, place the following in a shaker: one quarter of a glass of sweetened concentrated milk, half a cup of strong coffee, a tablespoon of crème de cacao and crushed ice. Shake and serve.

### *IRISH COFFEE*

For each person, place the following in a large glass: 30g. (1 oz.) of caster sugar, two fingers of whisky, half a cup of hot, black coffee and a spoonful of fresh cream. Drink without stirring.

### *CAFÉ AU CHOCOLAT*

Melt in a small pan three small bars of chocolate with half a glass of water. Mix with half a litre of strong coffee. Add 100 g. (3.5 oz.) of sugar, three tablespoons of fresh cream and a pinch of cinnamon. Serve chilled.

### *CAFÉ ROYAL*

Hold a spoonful of rum over a hot, well-sweetened cup of coffee. Set the rum alight and, while flaming, pour it into the cup.

### *COFFEE ICE LIÉGEOIS*

Bring to the boil half a litre of milk containing half a vanilla pod. Mix this with a half litre of coffee sweetened with 300 g. (10.5 oz.) of sugar, and add 1/4 litre of fresh cream. Place the mixture in an icecream maker, if available, and freeze until half frozen. Whisk with an electric mixer and leave in the freezing compartment until hard. Beat the mixture again on removing from the refrigerator. Serve in dishes or tall glasses and top with a spoonful of whipped cream.

### *ICED YOGURT*

For each person, whisk a container of plain yogurt until creamy. Mix in 50 g. (1.5 oz.) of sugar, a teaspoon of cream and half a cup of very strong coffee. Pour into large glasses and chill in the refrigerator.

### *GRANITA*

For each person, place one cup of very strong, cold, sweet coffee in a shaker. Shake well with a quarter of a cup of crushed ice. Pour the coffee into a glass and mix in a tablespoon of whipped cream. Serve immediately while cold.

### *WINTER COFFEE*

For each person, place the yolk of an egg and 30 g. (1 oz.) of sugar in a whisky glass and mix until frothy. Stir in a cup of hot coffee and a liqueur glass of rum. Serve while still frothy.

### *TROPICAL NECTAR*

Place a scoop of coffee ice cream and a teaspoonful of Angostura in half a glass of iced coffee. Cover with heavy cream.

### *ICED COFFEE OPÉRA*

For each person, use a blender to mix half a glass of cold coffee with one or two tablespoons of vanilla ice cream.

### *ITALIAN TIPPLE*

For each person, mix half a cup of very strong coffee, a spoonful of sweetened concentrated milk, half an egg yolk, half a glass of Vermouth, the rind of a lemon, a little cinnamon and crushed ice. Mix in a shaker or blender and serve at once.

### *CAFÉ FRAPPÉ*

For each person, mix in a shaker two tablespoons of sweetened concentrated milk, a small cup of strong coffee, a pinch of powdered vanilla and a little crushed ice.

### *BRAZILIAN COFFEE*

For each person, mix in a shaker two tablespoons of rum, a glass of black coffee, 50 g. (1.5 oz.) of icing sugar, a pinch of vanilla sugar, a spoonful of fresh cream, the rind of a lemon and crushed ice.

## TROUBLESHOOTING

PROBLEM	SOLUTION
<ul style="list-style-type: none"> <li>• Machine does not work and switch light does not come on</li> </ul>	<ul style="list-style-type: none"> <li>• Switch to "ON" position</li> <li>• Plug in</li> </ul>
<ul style="list-style-type: none"> <li>• Coffee does not come out</li> </ul>	<ul style="list-style-type: none"> <li>• Check that the switch is set to "ON "</li> <li>• Fill the water tank</li> <li>• Grind coffee more coarsely</li> <li>• Reduce the quantity of coffee in the filter</li> <li>• If you have used your machine for a few months, follow descaling instructions on page 8</li> </ul>
<ul style="list-style-type: none"> <li>• Coffee comes out too quickly</li> </ul>	<ul style="list-style-type: none"> <li>• Use finer ground coffee</li> <li>• Increase the quantity of coffee in the filter</li> </ul>
<ul style="list-style-type: none"> <li>• Coffee comes out too thick or too slowly</li> </ul>	<ul style="list-style-type: none"> <li>• Use more coarsely-ground coffee</li> <li>• Reduce the quantity of coffee in the filter</li> </ul>
<ul style="list-style-type: none"> <li>• Coffee comes out from the filter-holder edge</li> </ul>	<ul style="list-style-type: none"> <li>• Insert the filter-holder correctly and pull to the right</li> <li>• Clean the edge of the filter-holder</li> </ul>
<ul style="list-style-type: none"> <li>• Coffee in the cup is cold</li> </ul>	<ul style="list-style-type: none"> <li>• Rinse filters, filter-holder and cups (or carafe) in hot water before making espresso coffee</li> </ul>
<ul style="list-style-type: none"> <li>• No steam is produced</li> </ul>	<ul style="list-style-type: none"> <li>• Check that the switch is in the "ON" position</li> <li>• Check that the steam knob has been turned correctly</li> <li>• No water in the reservoir tank</li> </ul>
<ul style="list-style-type: none"> <li>• The milk does not foam</li> </ul>	<ul style="list-style-type: none"> <li>• No milk in the milk container or no water in the reservoir tank.</li> <li>• Wait until the "OK" pilot lamp lights.</li> <li>• Check that the steam knob has been turned counter-clockwise</li> <li>• Use fresh milk (not boiled)</li> <li>• Check that the milk container and the rubber joint have been inserted correctly</li> <li>• Clean the the mixer and the rubber joint.</li> </ul>

The De'Longhi logo is centered at the top of the page, enclosed in a dark oval with a white border. The text 'De'Longhi' is written in a bold, sans-serif font.

## Limited Warranty

**What Does This Warranty Cover?** We warrant each Espresso Coffee Machine to be free from defects in material and workmanship. Our obligation under this warranty is limited to replacement or repair, free of charge at our factory or authorized service centers, of any defective part or parts there of other than parts damaged in transit, which shall be returned to us, transportation prepaid. This warranty shall apply only if the Espresso Coffee Machine is used in accordance with the factory directions which accompany it.

**How Long Does The Coverage Last?** This warranty runs for one year from the date of delivery and applies only to the original purchaser.

**What Does This Warranty Not Cover?** This warranty does not cover defects or damage of the Espresso Coffee Machine which result from repairs or alterations to the machine outside our factory or authorized service centers, nor shall it apply to any Espresso Coffee Machine which has been subject to abuse, misuse, negligence or accidents. Also, consequential and incidental damages resulting from the use of this product or arising out of any breach of contract or breach of this warranty are not recoverable under this warranty. Some states do not allow the exclusion or limitation of incidental or consequential damages, so the above limitation may not apply to you.

**How Do You Get Service?** If repairs become necessary or spare parts are needed, please write to:

De'Longhi America Inc.  
625, Washington Avenue  
Carlstadt N.J. 07072  
or call Service Tel. No. 800-322-3848

The above warranty is in lieu of all other express warranties and representations; All implied warranties are limited to the applicable warranty period set forth above. This limitation does apply if you enter into an extended warranty with De'Longhi. Some states do not allow limitations on how long an implied warranty lasts, so the above exclusions connection with the sale or use of its Espresso Coffee Machine.

**How Does State Law Apply?** This warranty gives you specific legal rights, and you may also have other rights which vary from state to state.