

Panasonic®

Epilator
Depiladora Eléctrica

Operating Instructions Instrucciones de operación

Model No./Modelo No.
ES2045

Service · Assistance · Accessories
800-338-0552(In USA)
www.panasonic.com/beauty

IN USA CONTACT:

Panasonic Consumer Electronics Company
Division of Panasonic Corporation of North America
One Panasonic Way 2F-3 Secaucus, NJ 07094

IN PUERTO RICO CONTACT:

Panasonic Sales Company
Division of Panasonic Corporation of Puerto Rico, Inc.
San Gabriel Industrial Park 65th Infantry Avenue KM9.5
Carolina, Puerto Rico 00630

IN CANADA CONTACT:

AU CANADA, CONTACTER:

Panasonic Canada Inc.
5770 Ambler Drive, Mississauga,
Ontario L4W 2T3
(905) 624-5010
Vancouver: (604) 278-4211
Calgary: (403) 295-3955
Toronto: (905) 624-8447
Montréal: (514) 633-8684

En México:

Panasonic de México, S.A de C.V.

México D.F.

Amores 1120, Col. del Valle, 03100
Tel: 54 88 10 00

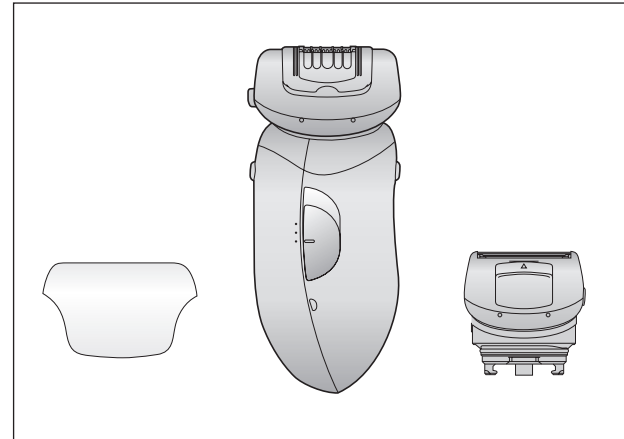

- Before operating this unit, please read these instructions completely, and save this manual for future use.
- Antes de utilizar esta unidad, por favor lea estas instrucciones completamente, y guarde este manual para uso futuro.

Printed in China
Impreso en China

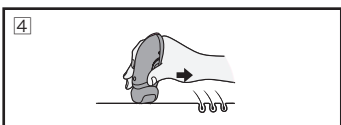
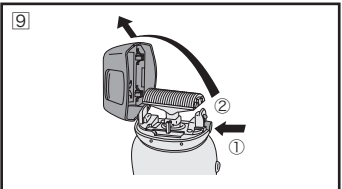
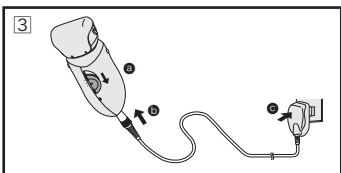
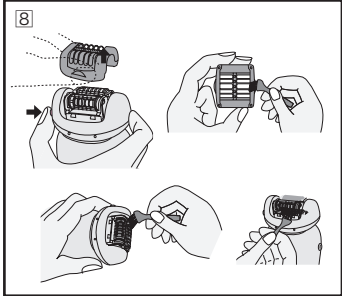
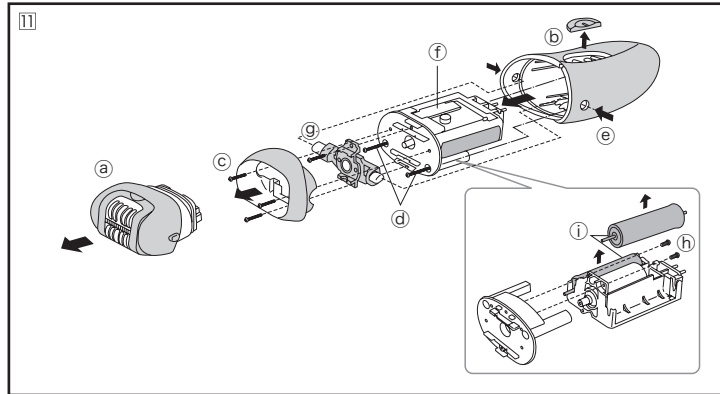
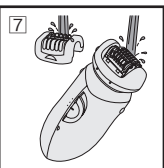
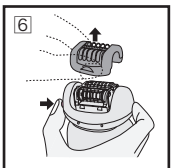
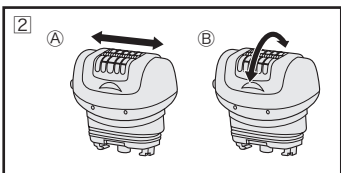
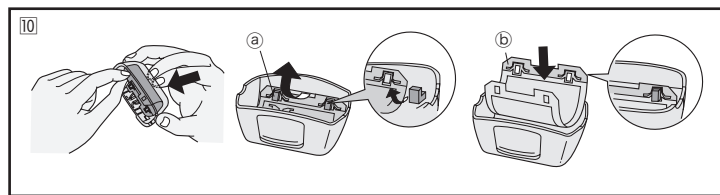
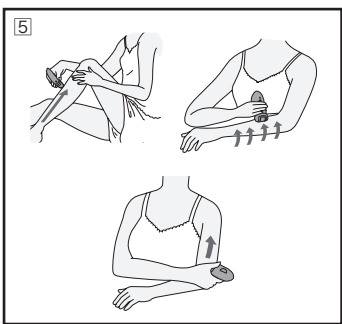
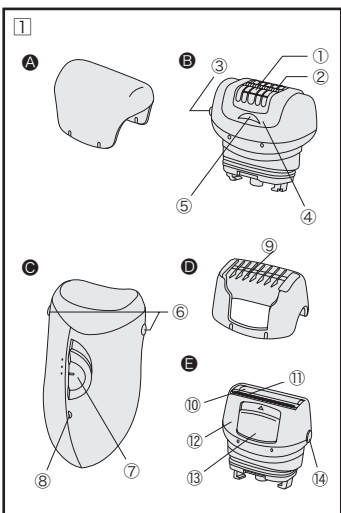

IMPORTANT SAFETY INSTRUCTIONS

When using an electrical appliance, basic precautions should always be followed, including the following:

Read all instructions before using this appliance.

DANGER To reduce the risk of electric shock:

- 1. Do not reach for an appliance that has fallen into water. Unplug immediately.
- 2. Charger unit is not for immersion or for use in shower.
- 3. Do not use an extension cord with this appliance.
- 4. Do not place or store appliance where it can fall or be pulled into a tub or sink. Do not place in or drop into water or other liquid.
- 5. Except when charging, always unplug this appliance from the electrical outlet immediately after using.
- 6. Unplug this appliance before cleaning.

WARNING To reduce the risk of burns, fire, electric shock, or injury to persons:

- 1. Do not use this appliance with damaged epilator/shaver heads as injury may occur.
- 2. An appliance should never be left unattended when plugged in.
- 3. Close supervision is necessary when this appliance is used by, on, or near children or invalids.
- 4. Use this appliance only for its intended use as described in this manual. Do not use attachments not recommended by the manufacturer.
- 5. Never operate this appliance if it has a damaged cord or plug, if it is not working properly, if it has been dropped or damaged, or dropped into water. Return the appliance to a service center for examination and repair.
- 6. Keep the cord away from heated surfaces.
- 7. Never drop or insert any object into any opening.
- 8. Do not use outdoors or operate where aerosol (spray) products are being used or where oxygen is being administered.
- 9. Always attach plug to appliance first, then to outlet. To disconnect, turn off the switch, then remove plug from outlet.

SAVE THESE INSTRUCTIONS

CAUTION

To reduce the risk of personal injury, follow these instructions:

- 1. Before use, check that the skin protector and epilator discs have not become misshapen or damaged.
- 2. Insert the charger securely into the appliance.
- 3. Use only the included charger RE7-36 to charge the ES2045 epilator.
- 4. Before use, always make sure that the epilator disks and outer foil are not damaged or deformed.
Failure to do so can cause damage to the skin.
- 5. Make sure skin is clean before and after use.
Always wipe away perspiration and keep skin in a hygienic state.
Failure to do so can cause infection and inflammation.
- 6. When beginning use of the appliance, allow your skin time to adjust by testing it gradually over a period of two to three days.
- 7. Discontinue if skin trouble continues for more than two days following treatment with the appliance.

- Please consult a dermatology specialist in such instances.
- 8. Always turn off the power switch when exchanging epilator or shaver heads.
Failure to do so could cause finger injury, or hair to become entangled in the spinning gears, or damage to the appliance.
- 9. Be careful not to let clothing or, etc., come in contact with epilator discs.
Failure to do so could result in becoming entangled in the discs.
- 10. Never allow the appliance to come in contact with the hair on your head, eyelashes, ribbons, etc., when switched on.
Doing so can cause personal injury or mechanical malfunction.
- 11. When unplugging, do so by pulling on the plug, not on the cord.
Failure to do so could cause electric shock or short-circuiting.
- 12. Avoid dropping the appliance or allowing it to strike hard surfaces.
Doing so can cause personal injury or mechanical malfunction.

Prohibited!

- Do not use on facial or genital areas or surrounding regions,

such as the groin, etc.
Doing so can cause damage to skin or inflammation.

• Do not use head for your underarms or bikini-line.

Doing so can cause damage to skin or inflammation.

• Do not use strong pressure to the skin, repeatedly rub over the same area, hold in one spot on the skin, or apply in a jabbing motion when using the appliance. When using the head with the appliance, do not keep it in constant contact with the skin while repeatedly moving it over the same area.

Doing so can cause damage to skin, inflammation or increased pain.

• Do not turn on the device without a epilator or shaver head attached. *Doing so could cause finger injury, entanglement of hair in the spinning gears, or mechanical malfunction.*

• Do not use the appliance if any of the following conditions are present.

- Eczema, rashes or other skin conditions

- Allergic constitution or sensitive skin that reacts to cosmetics, clothing, metals, etc.

- Proneness to infections

- Varicose veins, diabetes, hemophilia, etc.

- Poor clotting of blood

Doing so can cause skin damage, sensitization, inflammation, bleeding, etc.

• Do not use near or on the following skin areas.

- Warts, pimples, bruises, rashes, wounds, or loose skin

Doing so can damage skin and cause inflammation or bleeding.

• Do not use under the following circumstances.

- Before or during menstruation, during pregnancy, or for about one month after giving birth

- When skin is sunburned

- When illness or signs of skin and other physical abnormalities are present

Doing so can sensitize skin and cause severe pain.

• Do not use in the following manner.

- Just before swimming in a pool or the ocean (use no less than two days prior)

- Shared use of the appliance with family or friends

- Just before intense exercise or sports activities

Doing so can result in bacteria entering skin via dilated pores due to epilation and cause infection and inflammation.

• Do not use nail polish remover, benzene, alcohol, etc., to clean the appliance.

Doing so can cause mechanical malfunction.

• Do not leave the appliance in places where it will be exposed to high temperatures or direct contact with sunlight.

Doing so can cause mechanical malfunction.

Before usage please read the manual carefully and completely.

Before use

This Ladies Wet/Dry epilator can be used for wet epilation with epilation lather or for dry epilation. You can use this watertight epilator in the shower and clean it in water. The following is the symbol of Wet epilator. The symbol means that hand-held part may be used in a bath or shower.

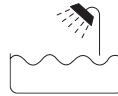

Our research has shown that you can enjoy closer and smoother epilation with the pivot action epilation system. And our pop-up trimmer will be able to cut longer hairs with ease. Treat yourself to wet epilation for at least three weeks and notice the difference. Cleaning is so simple. Just rinse out the epilation head under the tap or shower. No mess, no fuss! Charge the epilator for at least 8 hours before using it for the first time or when it has not been in use for more than six months.

Part names (Fig. 1)

- Ⓐ Protection cap (x2)
- Ⓑ Epilation head for legs/arms
 - ① Epilation discs (inside)
 - ② Skin protector (metal part on the outside)
 - ③ Frame release button
 - ④ Legs/arms frame

- ⑤ Protrusion (on both sides)
- Ⓒ Main body
 - ⑥ Head release button
 - ⑦ On/off switch
 - 0 = 0-charge
 - 1 = low speed
 - 2 = normal speed
 - ⑧ Charging light
- Ⓓ Bikini comb (Interchangeable with the shaver cap)
- ⑨ Comb
- Ⓔ Shaver head
 - ⑩ Outer foil (Net blade)
 - ⑪ Trimmer
 - ⑫ Frame
 - ⑬ Trimmer handle
 - ⑭ Frame release button

Accessories:

Charger, cleaning brush and pouch

Epilation and hair cycle What beginners should know and observe!

Hair replaces itself in regular intervals. For every hair that dies another one grows. This sequence is called the hair cycle.

There are 3 stages to consider. In the first stage, hair is in its 'growth period'. The root of the hair is embedded deep in the dermis at a stage where it is fully grown.

The next stage is where hair is in its 'rest period'. Hair does not grow at this stage.

When hair falls out, it gets smaller and lighter and moves towards the epidermis. It is pushed out by the new hair growing underneath

it. This last for about 3 months. At the end of the cycle, a hair bud' situated at the base of the 'rest' root develops and will push the hair out at the last stage of the cycle.

When carrying out epilation for the first time or for the first time in the season, you may experience some pain as there will be a large number of hairs. This pain will decrease after the second time you use the appliance, as the number of hairs will be reduced. The degree of pain experienced differs from person to person.

Immediately after epilation you may see some tiny spots of blood or red marks. In such cases apply a cold towel to the affected area.

We recommend using the appliance immediately after bathing.

Always let the hair grow for at least three days before carrying out epilation again.

In some cases, however, depending on the "hair cycle" you may find it is not possible to remove hairs even after three days. We recommend removing short hairs gently by plucking or shaving them.

As this is not permanent epilation, we recommend that you use the appliance regularly, about once every two weeks for the legs and arms.

Wipe the moisture and sweat off your skin.

Keep the skin in a hygienic, dry state without using body lotion, skin milk, powder or antiperspirant.

Moving head (Arms/legs epilation head) (Fig. 2 Ⓐ)

- The head moves to the left and right to quickly carry out epilation on short hairs.

This feature promotes efficient epilation.

Swinging head (Arms/legs epilation head) (Fig. 2 Ⓑ)

- The head swings to ensure that it stays in close contact with the skin.

Changing the head

- Hold the head release button down while removing the head.
- When attaching a head, push it on until you hear a "click". (Press the head on until it is attached securely to the body.)

Charging the appliance

(Fig. 3)

- Slide the switch on the epilator to the 0-charge position. (Ⓐ)
- Plug the charger into the epilator (Ⓑ) and the electrical outlet (Ⓒ).
 - Moving the switch on the appliance to 2 or 1 position makes it possible to use the unit while it is plugged into the power outlet.
- Charge the appliance for approximately 12 hours. (The charging light will stay on even after 12 hours.) The epilator can be used for approximately 30 minutes on a single full (12 hours) charge.
- When using the epilator for the first time or using it for the first time in over 6 months, please ensure that you charge the appliance

for approximately 20 hours. As batteries supply electricity through chemical reaction, if left for long periods of time without being charged they become difficult to charge (inactivated) and it is necessary to charge them for approximately 20 hours in order to reactivate them.

- In some cases the charging light may not come on even after a few minutes and even though the charger is plugged in securely. In such cases please continue to charge the appliance and the charging light will eventually come on.
- After the appliance has been fully charged it is OK to leave the appliance plugged in.
- As the charging current is controlled, the life of the batteries does not deteriorate. There is generally a memory effect whereby the voltage will be reduced if the appliance is repeatedly charged and discharged without completely using the capacity of the batteries. If the appliance is used until no charge remains in the battery and then charged for 20 hours, this effect will disappear.
- Please use the charger provided to charge the battery.
- Please charge and use the appliance at a temperature of between 5~40°C (41°~104°F).
- It is perfectly normal for the appliance to become slightly warm when being charged or used.
- If the cord becomes damaged it is not possible to replace only the cord. Please contact your nearest

dealer or Panasonic Customer Service Center.

- When removing the charger please do not do so by pulling on the cord.

NOTE: The appliance will not charge if the switch is in any position other than 0-charge.

Always check to see that the charging light is on.

How to operate your epilator

Cordless operation of the epilator (Wet epilation)

- Remove the cap.
- Attach the head you wish to use.
- Place a small quantity of liquid body soap on the discs.
- Wet the discs.
- Slide the switch to 1 or 2 position and carry out epilation.

NOTE: Allow the discs to spin and foam up the soap.

Always use liquid body soap when carrying out epilation. Using just cold or warm water without soap will hinder the movement of the epilator.

Please see "Use foam to achieve the best results" for details.

- Always wash the discs well after use to remove any residual soap.

NOTE: If soap is left on the discs then a white deposit can accumulate and prevent the blades from moving smoothly.

Use the supplied brush to remove any remaining hair.

- After epilation slide the switch to the 0-charge position.

NOTE: Remove any dirt with a

dry cloth and allow the appliance to dry thoroughly. Leaving the appliance wet for long periods of time can cause malodor.

Use foam to achieve the best results

- Apply sufficient foam.
Note: The foam guides the hair into the discs. If there is insufficient foam, then there is the possibility that the hair may not be removed, making it difficult to properly carry out epilation.
- Ensure that the foam is firm enough.
NOTE: If the foam is too soft, then it will be difficult to catch the hair. Increase the volume of liquid body soap or reduce the volume of water to make the foam firmer. The foaming characteristics and the firmness of foam will vary depending on the characteristics of the body soap used.
- Apply the epilator at right angles to the skin and move it slowly.
Note: After the foam is applied it is easy to move the epilator too quickly. Take care to place the head lightly against the skin and move it slowly.

Cordless operation of the epilator (Dry Epilation)

- Remove the cap.
- Attach the head you wish to use.
- Slide the switch to 1 or 2 position and carry out epilation.
- After completing epilation, slide the switch to the 0-charge position.

NOTE: Always make sure that the epilation discs and skin protector have not become damaged, cracked or misshapen. If they are, then please do not use the appliance.

Failure to do so can cause damage to the skin.

If you are concerned about pain during epilation then please use the 1 position. However, bear in mind that people sense pain differently so in some cases you may feel more pain on the 1 position.

The movement of the discs makes some noise but this is perfectly normal.

Please do not drop the appliance or bang it against anything solid.

(This can cause the skin protector or epilation discs to become damaged, cracked or misshapen.)

Correct usage for best epilation results

- For the first use, or if not having epilated for a long time, we recommend trimming hairs before epilation. Leg and arm hair should be shortened to a length of 3 to 5 mm.
- Apply epilator at right angles (90°) against your skin. For best epilation results keep in contact with the skin surface. Pressing gently and guide the appliance slowly against hair growth. This switch-side of the appliance shows against hair growth. (Please see the fig. 4)
- Rub your skin to lift short hairs.
- Move the epilator slowly on

the skin with the skin protector vertically touching against it.

NOTE: You may drop some hair so please lay out a piece of paper, etc. to catch it.

Legs and arms epilation (Fig. 5)

When epilating legs or arms, please use the epilation head.

Do not use this head on the underarm or on the bikini line.

Important for arms and legs epilation: Apply epilator at right angles (90°) against your skin.

Pressing the appliance too hard onto the skin or using it on an angle can cause damage to the skin.

Press gently and guide the appliance slowly against hair growth.

If you move the appliance too fast then you will find a large number of missed hairs.

- Holding the appliance correctly
Place your thumb on the area around the switch and hold the appliance from the side.
Touching the head with your finger can interfere with the operation of the appliance.

Legs: Move the appliance upwards from the bottom of the leg.

Arms: Move the appliance inwards from the outside of the arm.

Upper arms: Move the appliance upwards from the bottom of the upper arms.

NOTE: When using the appliance on areas where the skin is prone to sagging (on the inside of the knees and elbows), pull and stretch the

skin so that it is tight.

Shaving Shaving with soap lather

Before using make sure the blade is not warped or damaged, as this may cause injury.

- Shaving with lather makes the skin slippery for a closer shave.
- Do not use shaving cream, skin cream, or skin lotion.
Doing so will clog the blades.

When the hair is short, it makes the hair removal easier and also reduces the pain to shorten the hair. If epilation is carried out when the hair is too long it can get caught inside the appliance and cause it to malfunction.

For legs and arms

It is helpful to use a shaver head with bikini comb.

For underarms and bikini-line

It is helpful to use a shaver head 3 to 5 days before using the epilator.

- Remove the bikini comb.
- Check that the outer foil is not warped or damaged.
- Slide the switch to either 1 or 2 position.

Shaving with bikini comb

Place bikini comb onto the shaver head, and slide trimmer up. When the bikini comb is in place, make sure the comb is in close contact with the skin.

Lift the trimmer to cut long hair

Lift the trimmer up.

- After using the trimmer to lift and cut hair that is long or laying down, use the outer foil to finish it off.
- Please use the brush to remove any hairs that is caught in the trimmer. Failure to do so can cause hairs to be missed.
- Use the bikini comb (integrated in the shaver head) to avoid damaging the outer foil.
- Before using the appliance for the first time, wipe away excess oil with a tissue, etc. to avoid getting the oil on the outer blade and your skin.

Apply the shaver head so that the whole of the blade is in close contact with the skin. Do not allow the surface of the blade to move up and down.

Press gently and guide the appliance slowly against hair growth. Applying with too much force prevents hairs from being guided to the blades which may lead to some areas not being shaved.

When the trimmer is up, apply the blade gently.

Further useful tips

- In the beginning, it is advisable to epilate in the evening so that any possible reddening can disappear overnight. When you feel pain or rash appears, cool the skin with cold towel.
- Hair is easier to remove after bathing or showering.
- It may happen that new grown fine hairs do not manage to get through

to the skin surface. In order to prevent the risk of ingrown hairs, we recommend the regular use of massage sponges, e.g. after showering, or exfoliation peeling. By gentle scrubbing action, the upper skin layer will be removed and fine hairs can get through to the skin surface.

Cleaning

Switch off and unplug the appliance before cleaning.

Washing your epilator

After using the appliance, always clean the frames and discs to keep them in a hygienic state.



Warning!

- Always unplug the charger from the electrical outlet and from the epilator before cleaning the appliance.
- Never use the charger in the bath or shower.
- Never wash or place the charger in water.



Caution!

- Make sure that no hair or clothing comes into contact with the discs and never attempt to touch them.
Failure to do so can result in them becoming entangled in the discs.

The epilation and shaver heads and main body can be washed.

We recommend washing each head. Take care not to deform or damage the skin protector during cleaning.

Cleaning with liquid hand soap is

unnecessary when liquid body soap is used for hair removal. Rinse off soapsuds and dry after use.

- Remove the frame by holding down the frame release button and placing your fingers on the protrusions on the front and back of the head. (Fig. 6)

In the case of the shaver head, remove the frame by grasping the edge of one side with the fingers. (Fig. 9)

Take care not to touch the skin protector as it can easily become misshapen.

- Apply conventional liquid hand soap to the discs and blade.
- Turn the switch on and then pour a little water onto the discs to create foam.
- Wash the head with cold or warm water to remove any hair. (Fig.7)

NOTE: Take care when doing so as there is the possibility that water may splash around.

Do not use hot water to wash the appliance. Use the supplied brush to remove any hair that is still stuck to the appliance.

If soap is not completely washed away, then a white deposit can accumulate and prevent the blades from moving smoothly.

- Slide the switch to the 0-charge position and wipe the appliance with a dry cloth.

NOTE: Do not apply pressure to the skin protector.

Leaving the appliance wet for long period of time can cause malodor.

- Store the leg/arm epilation and shaver heads with their caps on.

Cleaning your epilator with the supplied brush

Cleaning of the epilation head (Fig. 8)

After using the appliance, always clean the frame and discs to keep them in a hygienic state.

- Remove the frame by holding down the frame release button and placing your fingers on the protrusions on the front and back of the head.

Take care not to touch the skin protector as it can easily become misshapen.

- Brush the epilation head. While cleaning, you can turn the epilation discs manually. Be careful not to break the skin protector when cleaning.

In some cases it is difficult to remove hair that has become stuck in the discs. In such cases, hold the appliance so that it is pointing down, rotate it a number of times and then clean it again with the brush. (Always ensure that the switch is off before doing so.)

When removing the frame, please do not touch the metal area on the side of the disc. Touching it can cause the appliance to malfunction.

Please do not use any brush other than the brush provided.

- For disinfection of the epilation discs please use only pure

- alcohol.
- Wipe the main body only with a damp cloth. The use of alcohol etc. may cause discoloration or deformation of the main body. Do not press down hard on the skin protector.
- After cleaning, put the protection cap on the epilation head.

Cleaning of the shaver head (Fig. 9)

After using the appliance, always clean the blades to keep them in a hygienic state.

- Remove the frame by lifting it from one side while pressing on the frame release button.
- Clean with the brush. Be careful not to apply too much force on the blade. Remove the hair that is caught on the front of the trimmer section by lifting the trimmer. Do not disassemble the outer blades or frames.
- Wipe the attachment area with a dry cloth.
- After cleaning, put the bikini comb on the shaver head.

Replacing the outer foil of the shaver head (Fig.10)

Never remove the outer foil for other reason than to change it.

Removing the outer foil

While pushing the outer foil gently with the fingers, use the fingernail to release the plastic panel (b) on the blade from the catches (a) on

the inside of the frame.

Fitting the new outer foil

Holding the outer foil so that the surface with the plastic panel (b) (i.e. the surface that will contact the inner blade) faces upward, insert into the frame so that the catches (a) on the frame fit into the holes on the foil.

We recommend that the outer foil be replaced every year and the inner blade be replaced every two years.

Safety precautions

- Use only the included charger.
- Please use the appliance at a temperature of between 5~40°C (41-104F°)
- Always ensure the appliance is operated on an electric power source matched to its rated voltage.
- Never operate the appliance if the cord or adapter are damaged or overly hot, or if the plug fits loosely in the power outlet.
- Keep the device away from sources of heat or flame.
- Do not allow the appliance to be used by, on, or near children.
- Do not allow the appliance to be used or left in the vicinity of sinks, bathrooms, or other high-humidity areas, where it could be exposed to water and moisture.
- Do not allow the appliance to be immersed in, splashed with, or

rinsed under water.

- Do not modify the cord or damage it in any way such as by bending, twisting or pulling on it unnecessarily.
- Do not wrap the output cord tightly around the appliance.
- Regularly clean the cord connector, which plugs into the appliance, to keep it free of dust and foreign objects such as pins, etc.
- Replace the shaving foil and the inner blade when you notice a reduced shaving performance.
- A damaged or defective appliance should be returned to the customer service center or to an authorized customer service agent.
- Do not attempt to use a defective appliance or repair the appliance yourself. Disassembly and repair should only be carried out by a qualified technician.
- The adapter can be positioned in a vertical or horizontal position.

For environmental protection and recycling of materials

This epilator contains Ni-MH batteries.

ATTENTION:

2 nickel metal hydride batteries that are recyclable power the product you have purchased. Please call 1-800-8-BATTERY for information on how to recycle the batteries.





How to remove the built-in rechargeable batteries before disposal of the epilator (Fig. 11)

The batteries in this epilator are not intended to be replaced by consumers. However, the batteries may be replaced at an authorized service center. The procedure described below is intended only for removal of the rechargeable batteries for the purpose of proper disposal.

- Always unplug the charger from the epilator before disassembling it.
- Always slide the switch to 1 or 2 until the batteries are completely discharged.
- Using a screwdriver, disassemble the unit in the following order.

1. Detach the epilation head (a) .
2. Remove the off/on switch (b) .
3. Remove the top section (c) of the epilator (3 screws).
4. Remove the two long screws (d) .
5. Push in the head release buttons (e) .
6. Push hard on the connector on the bottom and take out the drive system (f) .
7. Remove the head release buttons (g) (1 screw).

8. Remove the battery holder section  (2 screws). (Please take care not to allow the batteries to short out on anything.)
9. Take out the two Ni-MH batteries .

Specifications

Power supply	Rechargeable batteries
Charging time	12 hours
Voltage	AC120V
Batteries	Ni-MH
Power consumption	Approx. 1W (When charging.)
Weight	Epilator (Approx. 185g with the big epilation head) (Approx. 170g with the shaver head)

Subject to change without notice.

This product is intended for house-hold use only.

READ ALL INSTRUCTIONS BEFORE USE

FOR YOUR CONVENIENCE, WE HAVE ESTABLISHED A TOLL-FREE (IN USA ONLY) NATIONAL ACCESSORY PURCHASE HOT LINE AT 1-800-338-0552