

| CONTENTS | Page |
|--|-------------|
| IMPORTANT SAFEGUARDS | 2 |
| LINE DRAWINGS (FIGURES 1-14)..... | 5-6 |
| WHO IS CAPRESSO? | 3 |
| WELCOME TO THE CAPRESSO CoffeeTEC..... | 7 |
| EQUIPMENT | 7 |
| FEATURES AND BENEFITS | 7 |
| 1. PREPARING THE CoffeeTEC | 8 |
| 1.1 Before First Use | 8 |
| 1.2 Setting the Clock and Timer | 8 |
| 1.3 Priming the frothXpress system | 8 |
| 2. MAKING COFFEE..... | 9 |
| 2.1 Filling the Water Container | 9 |
| 2.2 Filling with Ground Coffee..... | 9 |
| 2.3 Placing the Stainless Steel Carafe | 9 |
| 2.4 Turning the Coffee Maker On..... | 9 |
| 2.5 Serving Coffee | 10 |
| 2.6 Pouring Coffee While Brewing | 10 |
| 2.7 Brewing Small Amounts of Coffee | 10 |
| 2.8 Making Multiple Carafes of Coffee | 10 |
| 2.9 Auto Shut-Off | 10 |
| 3. AUTOMATIC BREWING AT A PROGRAMMED TIME | 10 |
| 4. KEEPING COFFEE HOT IN THERMAL CARAFES | 10 |
| 5. FROTHING MILK | 11 |
| 5.1 Assembly of the frothXpress System | 11 |
| 5.2 Adding Milk | 11 |
| 5.3 Brewing Coffee <i>and</i> Frothing Milk | 11 |
| 5.4 Frothing Milk Only | 11 |
| 5.5 Producing Frothed Milk | 11 |
| 5.6 Regulating Milk Froth and Temperature | 11 |
| 5.7 Green Steam Light Off | 12 |
| 5.8 Recommendations for Cappuccino and Latte | 12 |
| 5.9 Using the Flexible Hose | 12 |
| 6. MAKING HOT CHOCOLATE | 12 |
| 7. CLEANING | 12 |
| 7.1 The frothXpress System | 12 |
| 7.2 The Milk Container | 13 |
| 7.3 The Coffee Maker | 13 |
| 8. DECALCIFYING..... | 13 |
| 8.1 Decalcifying With Durgol | 13 |
| 8.2 Using Other Decalcifying Agents | 14 |
| 8.3 Decalcifying Hose | 14 |
| 9. TROUBLESHOOTING | 15 |
| 10. WARRANTY | 15 |
| 11. PRODUCT REGISTRATION | 16 |

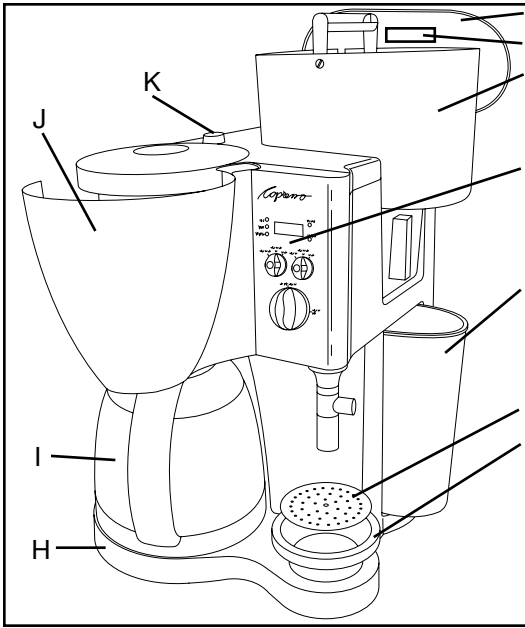

- A. Water Container Lid
- B. Sticker: Capresso Plus Service
- C. Water Container (removable)
- D. Display and Operating Panel (see figure 2)
- E. Milk Container with Lid
- F. Drip Grid
- G. Drip Tray
- H. Platform
- I. Stainless Steel Carafe with Lid
- J. Swing-Out Filter
- K. Push Button for Swing-Out Filter

FIG. 1

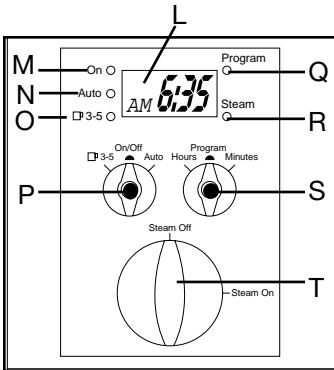

- L. LCD Display
- M. On Light (red)
- N. Auto Light (green)
- O. 3-5 cup Light (green)
- P. On/Off Button with Knob for 3-5 cup Setting and Auto Setting
- Q. Program Light (green)
- R. Steam Ready Light (green)
- S. Program Button with Knob for Hour and Minute Setting
- T. Steam Selector

FIG. 2

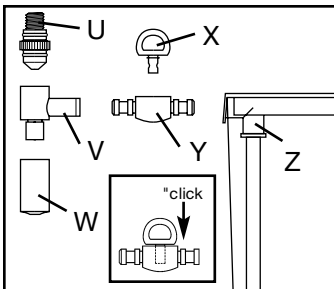

- U. Steam Nozzle
- V. Connector
- W. Frothing Sleeve
- X. Knob (for regulating froth)
- Y. Joint
- Z. Milk Container Lid with Siphoning Straw

FIG. 3

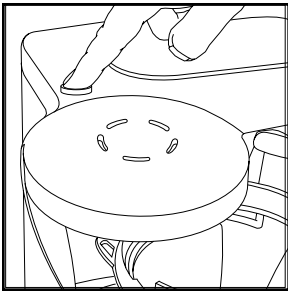

FIG. 4

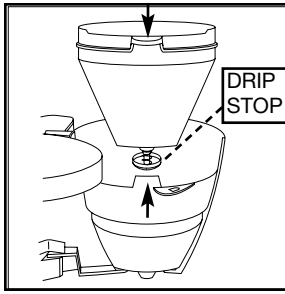

FIG. 5

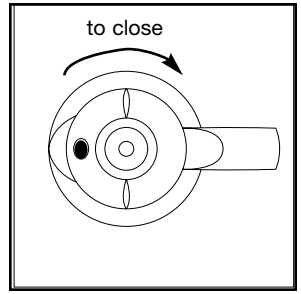

FIG. 6

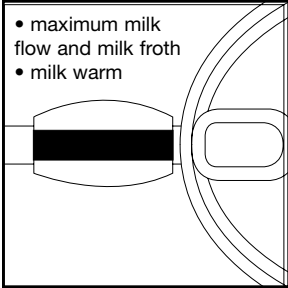

FIG. 7

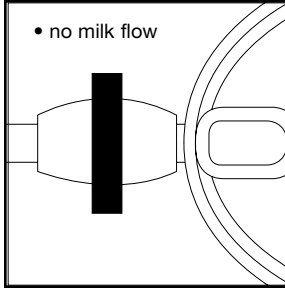

FIG. 8

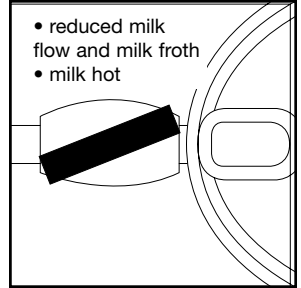

FIG. 9

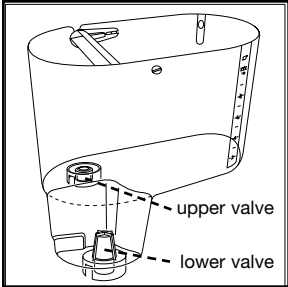

FIG. 10

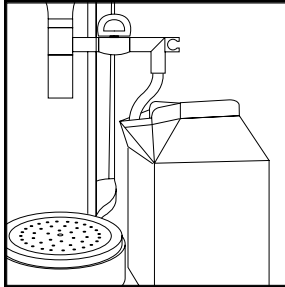

FIG. 11

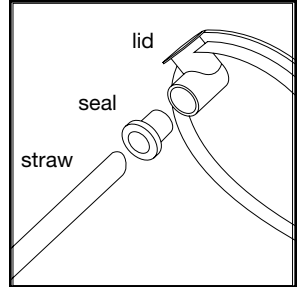

FIG. 12

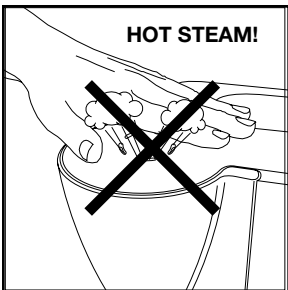

FIG. 13

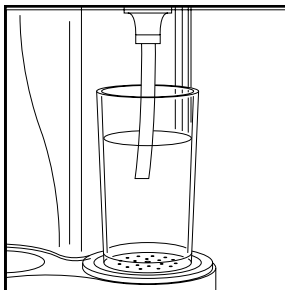

FIG. 14

WELCOME TO THE CAPRESSO CoffeeTEC

Thank you for choosing this unique CAPRESSO product. Your new CoffeeTEC has two distinctly different functions which work completely independently of each other: **Brewing Coffee** and **Frothing Milk**. Please study these operating instructions carefully before operating your new CoffeeTEC and keep them in a safe place for easy reference in the future. Understanding and complying with these directions is essential to ensure that the machine is utilized without risk and to ensure safety during operation and maintenance. Should you require further information or if particular problems occur that are not covered in this manual, please contact your local dealer or **call our toll free HELP LINE: 1-800-767-3554 9AM to 9PM Eastern Standard Time, Monday through Friday and 9AM to 5PM on Saturday.** If you call at any other time, please leave a message with your telephone number and when we can call you back. You can also send us a **fax at 1-201-767-9684, or e-mail us at contact@capresso.com.**

EQUIPMENT

The CoffeeTEC comes complete with:

- Stainless Steel Carafe with Lid
- GoldTone Filter (inserted in removable Filter Holder)
- Removable Water Container
- Measuring Scoop and Mail Order Form for Parts and Accessories

frothXpress System with:

- Milk Container with Lid and Siphoning Straw attached
- Steam Nozzle (figure 3; U) attached to machine
- 4-piece Frothing Assembly (figure 3; V, W, X, Y) packed in Milk Container
- Special Decalcifying Hose (see figure 14)
- Flexible Siphoning Hose (see figure 11)
- Drip Grid and Drip Tray (figure 1; F, G)

FEATURES AND BENEFITS OF THE CoffeeTEC

- 10-cup coffee maker with stainless steel vacuum carafe keeps coffee hot for up to 4 hours without reheating. (A full pot of coffee is more than 180° F after brewing, and more than 160° F after 4 hours.)
- Carafe lid is closed during the brewing process, preventing aroma and heat loss. Since lid is closed, carafe can remain on the platform after brewing has finished.
- Safety push button swing-out filter prevents accidental opening.
- Drip-stop allows you to pour a cup of coffee while brewing.
- Removable filter holder for easy cleaning.
- Fast brewing process allows you to brew 10 cups of coffee in under 8 minutes. (Remember the shorter the brewing time, the less bitter your coffee tastes.)
- Illuminated digital programmable clock/timer displays the time and allows you to program the coffee maker to make coffee anytime you want.
- Five signal lights indicate the status of your CoffeeTEC.
- Removable water container has cup markings and two water compartments for coffee and steam. Automatically fill water for brewing coffee *and* frothing milk, or just fill water for frothing milk.
- Patented frothXpress System instantly delivers hot milk or milk froth for up to 8 regular cappuccinos at a time, directly into your coffee mug or cappuccino cup. No frothing pitcher needed, no waste of milk, simply the fastest way to produce frothed milk.
- frothXpress System can also be used to produce hot chocolate.
- 2-hour safety auto shut-off.

1. PREPARING THE CoffeeTEC

1.1 Before First Use

- a. After unpacking your CoffeeTEC clean all the loose parts with warm water and make yourself familiar with the different functions.
- b. After reading these instructions, let some water run through the coffee maker to clean all internal parts.

1.2 Setting the Clock and Timer

When you plug in the CoffeeTEC the green display will flash "AM 12:00" and all indicator lights are off.

To set the current time:

Turn and hold the program knob to the left (hours) to set the hours (see fig. 2; S). While you are doing this, watch the AM change to PM. Then turn and hold the program knob to the right (minutes) and set the minutes (see fig. 2; S).

To set the programmed time:

- a. Push the program button (see fig. 2; S). The Program light (see fig. 2; Q) will go on and the display will show "AM 12:00."
- b. Turn and hold the program knob to the left (hours) to set the hours. While you are doing this, watch the AM change to PM. Then turn and hold the program knob to the right (minutes) and set the minutes. Within four seconds, the display will revert to the current time and the program light will turn off.
- c. To change the programmed time, push the program button (see fig. 2; S). It will show the programmed time. Then set the time as described above in step b.
- d. To check the programmed time, push the program button. The display will show the time you have programmed to brew coffee. The display will switch back by itself to the current time after a few seconds.

Attention: Flashing LCD Display

(see fig. 2; L)

If you unplug the coffee maker for more than 15 seconds or if you have a power failure, you will lose the current time and program settings. The display will flash "AM 12:00" indicating that you have to reset the current and programmed time.

1.3 Priming the frothXpress system

Before using the CoffeeTEC for the first time to make coffee or to froth please proceed as follows:

1. Remove water tank.
2. Fill only the lower part of the water tank about half full (see fig. 10)
3. Replace water tank and push down so that it engages properly.
4. Turn machine on (button P, fig 2)
5. Within 60 seconds the green Steam Ready Light will go on (R, fig. 2).
6. Place a large cup underneath the steam nozzle.
7. Wait approx. 30 seconds. Turn the Steam Selector Switch (T, fig. 2) all the way to the right - to the "Steam On" position – until you feel resistance.
8. Allow steam to release for 30 sec.*
9. Turn the Steam Selector Switch back to the "Steam Off" position to stop the steam action.
10. The frother is now primed and ready for use on a regular basis.
11. Turn the machine off (push button P, fig. 2; the red light M will go off).

***Attention:** If steaming should stop by itself before 30 seconds are up, turn the Steam Selector Switch back to "Steam Off" and wait until the green Steam Ready Light turns on again (this will take approx. 2 minutes). Then repeat steps (6) through (11) one more time. The frother should now steam without interruption for 30 seconds or longer.

2. MAKING COFFEE

2.1 Filling the Water Container

- Open the water container lid and remove the water container (fig.1; C).
- Fill the water container to the required marking with fresh, cold water (see fig. 10). **Caution:** Never fill water container above the “Max Line”—this is the line between the number “10” and the letters MAX. If you fill more water into the water container the stainless steel carafe could overflow with hot coffee which can cause severe injuries.
- Replace the water tank and close the water tank lid. When filling the water tank to brew coffee you will automatically have water left over for frothing milk (see section 5).
ATTENTION: Make sure the tank is completely inserted so that the two valves connect with the machine.

2.2 Filling with Ground Coffee

- a. Push the button to open the swing-out filter (see fig. 4). On the inside you will find a removable GoldTone filter and a removable filter holder.
Caution: The handle of the filter holder has to sit over the raised plastic part of the filter (see fig. 5). If the filter holder is not inserted properly, it is not possible to close the swing-out filter back into machine.
- b. Fill the GoldTone filter with ground coffee. If you would rather use a paper filter, use size 4. Please follow the instructions on the filter paper box for proper use of filter paper.
- c. **Important: Coffee Amounts**
Never use more than the amounts indicated in the following chart. Using more coffee than indicated could result in an overflow of ground coffee running into the carafe and blocking the drip stop function.

| Maximum # of Scoops | GoldTone Filter | Size 4 Paper Filter |
|-------------------------------------|-----------------|---------------------|
| Regular Grind (Supermarket Version) | 13 scoops | 16 scoops |
| Fine Grind (finer than regular) | 8-9 scoops | 10-11 scoops |

- d. Close the swing-out filter until it firmly clicks in place (see fig. 1; J).

2.3 Placing the Stainless Steel Carafe

Caution: Remove the carafe lid and make sure that the carafe is empty before brewing coffee.

- Place the carafe lid on the carafe with the large dot facing the pouring spout (see fig. 6).
 - Turn clockwise approx. 1 1/2 turns to firmly close lid. Although the lid is closed, the coffee can flow into the carafe through a one-way opening device on the lid.
- Attention:** Please note that the lid must be on the carafe during brewing to activate the drip stop. **If you lose the lid, you can not brew coffee.** Please call 1-800-767-3554 to order a new lid.
- Place the carafe on the platform. Make sure the swing-out filter is closed with the filter holder in place.

2.4 Turning the Coffee Maker On

Push the on/off button (see fig. 2; P) and the red on light (see fig. 2; M) will illuminate, indicating that the brewing process is starting.

Caution: Never open the swing-out filter while brewing coffee. Wait until the brewing process is completed. Remove the carafe first, and then open the swing-out filter. This prevents spilling.

After the coffee maker has finished brewing, remove the carafe from the platform. Turn the lid counterclockwise until the large round dot is over the pouring spout. You can now serve coffee. After serving make sure to close the lid securely.

CAUTION: Do not store carafe on its side or upside down. Hot coffee can drip out of the air release valve.

2.5 Serving Coffee

Brewing time for a full pot of coffee is under 8 minutes. When using a finer grind, it can take an additional two to four minutes until all the water has processed through the ground coffee.

2.6 Pouring Coffee While Brewing

You can pull the carafe from the platform during the brewing process for approx. 20 seconds to pour a cup of coffee. Make sure the lid is closed before you replace the carafe on the platform.

2.7 Brewing Small Amounts of Coffee

When brewing small amounts of coffee, we always recommend rinsing the carafe with hot water and switching to the 3-5 cup brewing cycle before you turn on the machine.

- Turn the on/off knob to the left, towards “3-5 cup” marking (see fig. 2; P). The green 3-5 cup indicator light (see fig. 2; O) will go on. This setting will slow down the brewing process and improve the temperature. When brewing 3 to 5 cups of coffee, temperature in the carafe after brewing will be between 174° F and 177° F.
- To cancel the 3-5 cup brewing cycle turn the on off knob to the 3-5 cup marking again. The 3-5 cup indicator light will turn off.

2.8 Making Multiple Carafes of Coffee

If you want to make another carafe of coffee immediately after the first

carafe is brewed, push the on/off button (see fig. 2; P) to turn the coffee maker off (the red light will turn off) and let the coffee maker cool down for approx. 5 minutes before refilling with fresh cold water and ground coffee. **Important:** Make sure the carafe is empty before brewing.

2.9 Auto Shut-Off

After brewing is finished the CoffeeTEC will go into stand-by mode for frothing. If you do not operate the machine within the next 2 hours, it will turn itself off automatically (the red light will turn off – fig. 2, M).

3. AUTOMATIC BREWING AT A PROGRAMMED TIME

- Set the programmed time at which you wish to brew coffee as described in section 1.2.
- Prepare the coffee maker as described in sections 2.1 - 2.3.
- Turn the on/off knob towards the Auto marking and let go. The green auto light (see fig. 2; N) will go on.
- At the pre-programmed time, the red on button will go on and the green auto light will go off, indicating that brewing has started.
- **Important:** If you inadvertently turned the on/off knob to the Auto marking you can turn the Auto light off by turning the knob towards the Auto marking again.

4. KEEPING COFFEE HOT IN THERMAL CARAFES

After brewing a full pot of coffee the temperature in the carafe will be above 180° F. If the carafe stays closed the temperature will gradually fall. After 4 hours the temperature will remain between 160° F and 165° F. The more often you open the carafe and the less coffee remains, the faster the temperature will decrease.

5. FROTHING MILK

The frothXpress System allows you to heat and froth milk directly into your cup. Like a pump espresso machine, the CoffeeTEC is equipped with a pump and a separate heating system to create hot steam. The frothXpress System works independently from the coffee brewing system.

Caution: Steam Pressure Release Through Top of Swing-Out Filter

(see fig. 13)

Any time you turn the steam selector (see fig. 2; T) from “Steam On” to “Steam Off,” the machine automatically releases the remaining pressure into the filter holder. As a result, a short, hot burst of steam will come out of the openings above the swing-out filter (see fig. 13). **Never place your hand or arm on this part of the machine. The hot steam can cause serious injury.**

5.1 Assembly of the frothXpress

- **Important:** In order to siphon milk through the frothXpress System all parts must be tightly connected. If the parts are loose, outside air might be entering the process, making it impossible to siphon the milk. Please refer to figure 3.
- Attach the connector to the steam nozzle until the red seal of the steam nozzle is no longer visible (see fig. 3; U to V). Next, attach the large hole of the frothing sleeve to the connector (W to V).

Insert the knob into the joint and make sure it clicks in place and sits tight (X to Y), and then insert the joint firmly into the connector (Y to V).

5.2 Adding Milk

Remove the lid of the milk container and fill with milk. Replace the milk container lid and connect with the joint (see fig. 3; Z to Y). Make sure that the knob sits parallel to the joint

(see fig. 7). (If it sits perpendicular to the joint no milk can be siphoned through the system; see fig. 8.)

5.3 Brewing Coffee and Frothing Milk

Fill the water container with the desired amount of water for coffee. By doing so, you automatically add the water necessary for frothing. The CoffeeTEC will first brew the coffee. After coffee brewing is finished, the machine will switch to stand-by position for frothing. The green steam light will go on (see fig. 2; R), indicating that the machine is ready to froth.

5.4 Frothing Milk Only

Only fill water in the lower part of the water tank (see fig. 10). Make sure that no water covers the upper valve. Push the on button (see fig. 2; P). The red light will illuminate. After approx. 60 seconds the green “Steam Ready” light will illuminate. Now you are ready to froth.

5.5 Producing Frothed Milk

Place a cup underneath the frothing sleeve (see positioning on cover of instruction book), and then turn the steam selector switch to the position “Steam On.” Make sure the knob sits parallel to the joint (see fig. 7). The frothXpress System will automatically dispense warm frothed milk into your cup. When you have enough frothed milk, turn the steam selector back to the position “Steam Off” (see fig. 2; T). As long as you have water in the lower part of the water container, you can continue frothing milk. When you are finished, disconnect the milk container and store with any unused milk in the refrigerator.

5.6 Regulating Milk Froth and Temperature

Maximum milk flow with maximum froth is achieved when the knob sits parallel to the joint (see fig. 7). By

slightly turning the knob towards the front or the back (approx. 20 to 40 degrees; see fig. 9) the flow of milk will be slowed down, increasing the milk temperature and decreasing the amount of froth. The temperature of the milk can vary between 110° F and 175° F depending on the position of the knob. **Attention:** If you turn the knob too much the milk will splatter. If the knob sits perpendicular to the joint (see fig. 8), the flow of milk is totally blocked. Only hot steam will pass through the frothXpress System.

5.7 Green Steam Light Off

When the machine is turned on and coffee brewing is finished, CoffeeTEC will automatically go into stand-by for frothing, indicated by the green steam light. The steam light will cycle between on and off. If the light is off and you want to froth, place a cup underneath the frothing sleeve and turn the steam selector (see fig. 2; T) to the position “Steam On.” Within 20 seconds, the steam heating system will heat up, the green steam light will come on, and frothing will start.

5.8 Recommendations for Cappuccino and Latte

If you want to serve multiple cups of cappuccino and latte at the same time, we recommend frothing your milk directly into your cups and then pouring the coffee through the frothed milk. This method keeps the froth very white in color. If you pour coffee into the cups first and then froth the milk on top of it, the froth will change to a brownish color. It's up to you to decide what method you like best.

5.9 Flexible Hose

Instead of using the milk container you can use the flexible hose (see fig. 11). Attach the flexible hose to the joint and insert the end of the hose directly into a small milk carton.

Important: The hose has to point

downwards to function properly (fig. 11). You can cut the hose to fit.

6. MAKING HOT CHOCOLATE

- Fill the milk container with cold milk, add chocolate syrup and stir well. Only fill water in the lower part of the water container. Make sure that no water covers the upper valve (fig. 10).
- Push the on button (see fig. 2; P) and the red light will turn on. Within 60 seconds the green “Steam Ready” light will illuminate (see fig. 2; R) indicating that you are ready to produce hot chocolate.
- Place a cup underneath the frothing sleeve and then turn the steam selector to the position “Steam On.” Make sure the knob sits parallel to the joint (see fig. 7). The frothXpress System will automatically dispense warm frothed chocolate into your cup.
- When you have enough hot chocolate, turn the steam selector back to the position “Steam Off.” By slightly turning the knob towards the front or the back (approx. 20 to 40 degrees; see fig. 9) the flow of chocolate milk will be slowed down, increasing the temperature and decreasing the amount of froth. **Attention:** Tiny chocolate particles can delay the siphoning of cold chocolate. Make sure that the knob sits parallel to the joint (see fig. 7), and let the frothing run for 10 to 15 seconds. The machine will automatically resume proper frothing. If this does not give you the desired result, turn the machine off, let it cool down for two minutes, and then turn the machine on and start frothing again.

7. CLEANING

7.1 The frothXpress System

If you do not clean the frothXpress System, hardened milk will deposit in the knob, joint, frothing sleeve, and the connector. Hardened milk deposits are very difficult to remove. Therefore, we highly recommend

cleaning the frothXpress System after each use as follows (it will take less than a minute):

- Disconnect the milk container from the joint (see fig. 3; Z from Y).
- Remove the four parts and immerse in a cup with warm water (knob, joint, connector, frothing sleeve) or rinse all parts under warm running water (see fig. 3; parts V, W, X, Y).
- Place a large cup underneath the steam nozzle and turn the steam selector to “Steam On” and let some steam run through for a few seconds. Turn the steam selector back to “Steam Off.”
- Assemble the system.

7.2 The Milk Container

- Remove the lid of the milk container. (The milk container is dishwasher safe; upper rack.)
- Hold the lid under warm running water and allow some water to run through the straw. For a more thorough cleaning take the lid assembly apart (lid, seal, straw).
- **Important:** When replacing the three parts, first insert the seal into the receptacle on the underside of the lid, and then push the straw inside the seal to ensure a tight fit (see fig. 12).

7.3 The Coffee Maker

- Always unplug the appliance from the outlet before cleaning.
- Never use scouring agents
- Never immerse the appliance in water or any other liquid, and never clean under running water. To clean the appliance, wipe off with a soft, damp cloth.
- **Dishwasher safe** (upper rack) parts: filter holder, GoldTone filter, drip grid, drip tray, water container and milk container (without lid).
- Make sure that the drip stop in the filter holder is free of any coffee particles, or else it might not close

properly when removing the carafe (see fig. 5).

- **Attention:** The swing-out filter is not removable.
- **Not dishwasher safe:** Stainless steel carafe. Wipe outside with a damp cloth. Rinse inside.

8. DECALCIFING

For prolonged use of your CoffeeTEC it is necessary to decalcify it regularly. Calcium (limestone) found in drinking water will leave deposits in the machine. We highly recommend that you **decalcify your machine at least every four months.**

- **Attention:** Before decalcifying, remove the GoldTone Filter from the machine.
- **When to decalcify:** A slowdown in brewing or insufficient steam output indicates that it is time to decalcify.

8.1 Decalcifying with Durgol

Capresso and many European companies recommend “DURGOL” - a liquid decalcifying agent that removes calcium deposits up to 20 times faster than vinegar.

1. Unscrew steam nozzle. Pour Durgol in a small cup and insert steam nozzle. Let it sit for five minutes. Discard Durgol and rinse steam nozzle thoroughly.
2. Replace steam nozzle.
3. Fill the water container up to the 5-cup marking with fresh cold water.
4. Replace water container into the coffee maker.
5. Add one cup of Durgol, so that the solution is at the 6-cup water level.
Attention: Never fill Durgol into the water container first.
6. Remove GoldTone filter.
7. Make sure that the filter holder is in place and that the carafe is empty.
8. Place the carafe with its lid in place on the platform.
9. Fill the milk container with approx. 10 oz. of fresh water (**no Durgol!**) and attach to the system.

10. Place a large mug (at least 12 oz.) underneath the frothing sleeve.
11. Turn the steam selector to the “Steam On” position.
12. Now turn the machine on by pushing the on button (see fig. 2; P).
13. The solution in the water tank will be pumped into the carafe.
14. After one minute, turn machine off and let it sit for 5 minutes.
15. Turn the machine on again and let the rest of the water run through the system into the carafe.
16. **Attention:** As soon as the brewing is finished the frothXpress System will start drawing water into the system and then deliver hot steam and water into the mug.
17. Let the frothXpress System run for 30 seconds. Then turn machine off for 1 minute and let the solution work.
18. Turn the machine on again and let the rest of the steam/water process continue.
19. When there is no more water in the milk container, turn the steam selector back to “Steam Off” and turn the machine off and let it cool down for five minutes.
20. Empty the stainless steel carafe and the water container and rinse both thoroughly with fresh water.
21. Fill the water tank with 8 to 10 cups and the milk container with 10 oz. of fresh, cold water and repeat steps 11-19.

8.2 Using Other Decalcifying

Agents

Please make sure only to use liquid decalcifying agents suitable for drip coffee makers and follow the instructions that come with the agent.

Attention: Decalcifying agents are acids and therefore must be handled properly. Please check the information on the packaging of the decalcifying agents before using.

8.3 Decalcifying Hose

In case the steam system is completely clogged with calcium deposits, proceed as follows:

1. Unscrew the steam nozzle and replace with the decalcifying hose (see fig. 14).
 2. Fill the water container up to the 5-cup marking with fresh cold water.
 3. Replace the water container into the coffee maker.
 4. Add one cup of Durgol, so that the solution is at the 6-cup marking on the water container.
- Attention:** Never fill Durgol into the water container first.
5. Remove the GoldTone filter.
 6. Make sure that the filter holder is in place and that the carafe is empty.
 7. Place the carafe on the platform.
 8. Fill a large mug with 5 to 6 oz. of cold water and place underneath the decalcifying hose so that the tip of the hose is submerged in the water (see fig. 14).
 9. Turn the machine on.
 10. The solution in the water tank will be pumped into the carafe. When the brewing is finished the machine will switch to standby mode for frothing (the green “Steam Ready” light will turn on).
 12. Turn the steam selector to the position “Steam On” and let steam run into the mug containing cold water. **Attention:** This will make a loud noise.
 13. Stop after approx. 30 seconds and wait for 30 seconds. Then repeat this step five to ten times.
 14. Empty the carafe and rinse thoroughly with fresh water.
 15. Run a complete cycle with fresh water through the machine and the frother.

9. TROUBLESHOOTING

Call the **CAPRESSO HELP LINE** at **1-800-767-3554** or email us at **contact@capresso.com** for warranty repair or replacement procedures.

- **Coffee drips from the filter, when the carafe is removed.**

--> Ground coffee sits in the drip stop and does not allow it to close properly.

--> Immediately replace the carafe and remove the filter holder.

--> Clean filter holder under running water and push the drip stop several times to remove coffee particles.

--> Fill some water into the filter holder and check if the drip stop closes properly.

- **Ground coffee is flowing over the GoldTone filter.**

--> Coffee is ground too fine.

--> Use less coffee the next time.

(See section 2.2)

--> Use a paper filter (size 4).

- **No steam.**

--> Fill some water into the water container. (See section 5.4)

--> Insert the water tank correctly.

--> Make sure the Steam Selector is turned all the way to the Steam On position.

- **Steam is o.k. but there is no frothed milk.**

--> Make sure that all pieces of the frothXpress System are tightly connected. (See section 5.1)

--> The knob must sit parallel to the joint. (See fig. 7.) and must be

totally inserted into the joint.

--> Check if the straw inside the milk container lid sits tightly (fig. 12).

--> Check if there is enough milk in the milk container.

- **Volume of milk froth is too low or frothing takes too long.**

--> Make sure the knob sits parallel to the joint. (See fig. 7)

--> Clean the steam nozzle, and frothing sleeve. (See section 7.1).

--> Decalcify the coffee maker. (See section 8 "Decalcifying.")

--> Try a low fat or no fat milk.

Remember, the higher the fat content in the milk, the lower the amount of froth produced.